

Vol.5



INTERIOR LIGHTING

www.southeastthailand.co.th

www.southeastthailand.co.th

31 03 2026



SALES Contact

LIGHTING

Tel: +66 (0) 85 661 7769



Tel : (662) 258-0210-5

Fax : (662) 258-1919

Email : Info@southeastthailand.co.th

Visit Out Show Room & Our Team

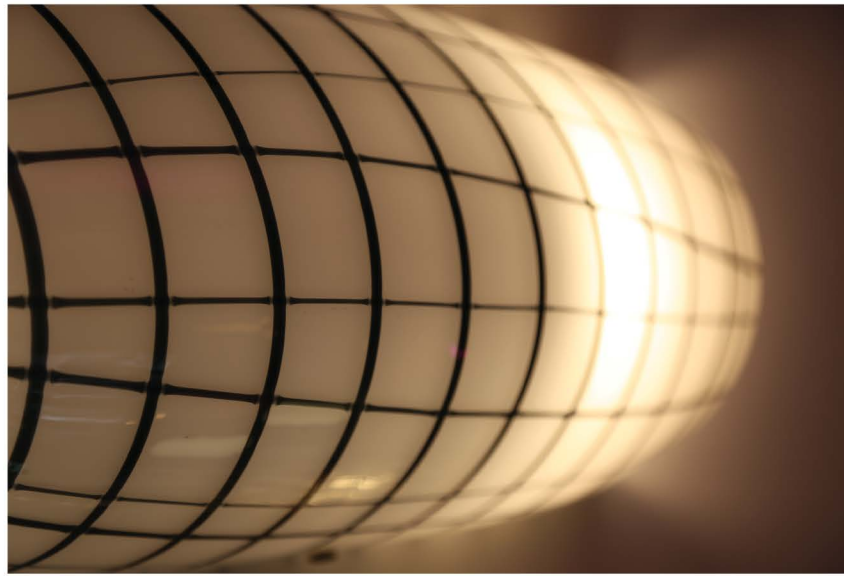

ABOUT

Southeast Thailand Co., Ltd. distributes a wide variety of lamps, including general-purpose interior and exterior lighting. We offer modern, unique lamp designs suitable for a variety of applications, including LED lamps such as downlights, wall lamps, ceiling lamps, and many other types of lamps. We offer a wide range of styles and designs,



from modern to classic, suitable for both indoor and outdoor use. Our state-of-the-art manufacturing standards ensure the quality of our LED chips, using world-class brands such as Lumileds, Cree, and Bridgelux, ensuring international standards and quality. Our representative products include European imports such as Klewe,

SOUTHEAST THAILAND CO., LTD.



Vistosi, Roger Pradier, and Traxon, as well as Southeast Thailand products under the LUCE brand. With our consistent success in using our products, whether for projects like premium condominiums, hotels, office buildings, residences, and shops, we are confident that we are one of the leading companies



offering a complete range of lighting products, all types, styles, and services, including after-sales service, to meet our customers' needs. Furthermore, we offer lighting consultation services by lighting experts, and have lighting designers to provide design services, whether for interior, exterior, or decorative lighting.

With over 50 years of experience in distributing lamps and providing various electrical and lighting services, we have a loyal customer base.



SOUTHEASTTHAILANDOFFICIAL



SOUTHEAST_THAILAND



WWW.SOUTHEASTTHAILAND.CO.TH

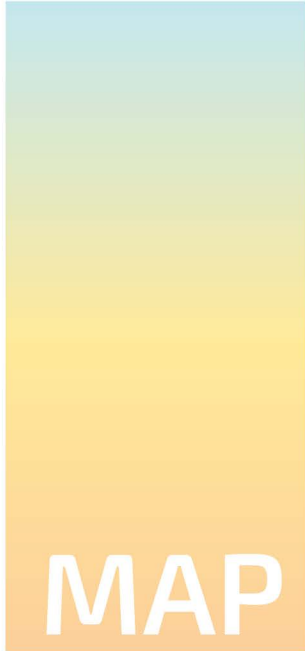

SOUTHEAST THAILAAND CO., LTD

390/6-7-8 Sukhumvit Rd.,
Klongtoey, Klongtoey,
Bongkok, 10110 Thailand



INFORMATION

Correlated Color Temperature (CCT)

Definition: the absolute temperature of a blackbody whose chromaticity most nearly resembles that of the light source. The correlated color temperature (CCT) is a specification of the color appearance of the light emitted by a lamp, relating its color to the color of light from a reference source when heated to a particular temperature, measured in degrees Kelvin (K). The CCT rating for a lamp is a general "warmth" or "coolness" measure of its appearance. However, opposite to the temperature scale, lamps with a CCT rating below 3200 K are usually considered "warm" sources, while those with a CCT above 4000 K are usually considered "cool" in appearance. The correlated color temperature (CCT) designation for a light source gives a good indication of the lamp's general appearance, but does not give information on its specific spectral power distribution. Therefore, two lamps may appear to be the same color, but their effects on object colors can be quite different, which could be further explained in color rendering index (CRI).

Reference: Lighting Research Centre (USA)

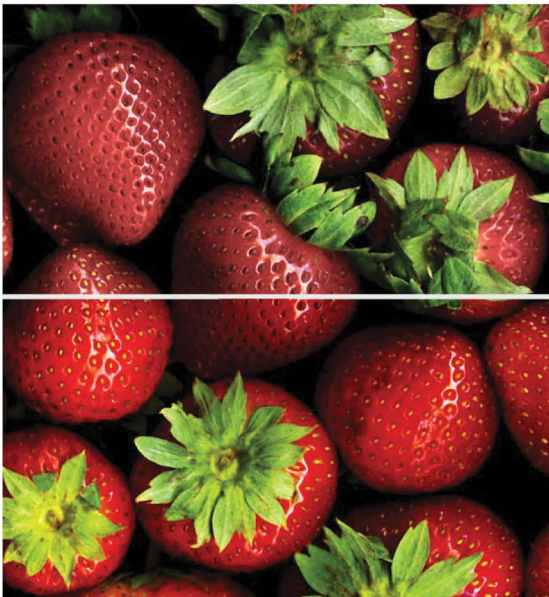
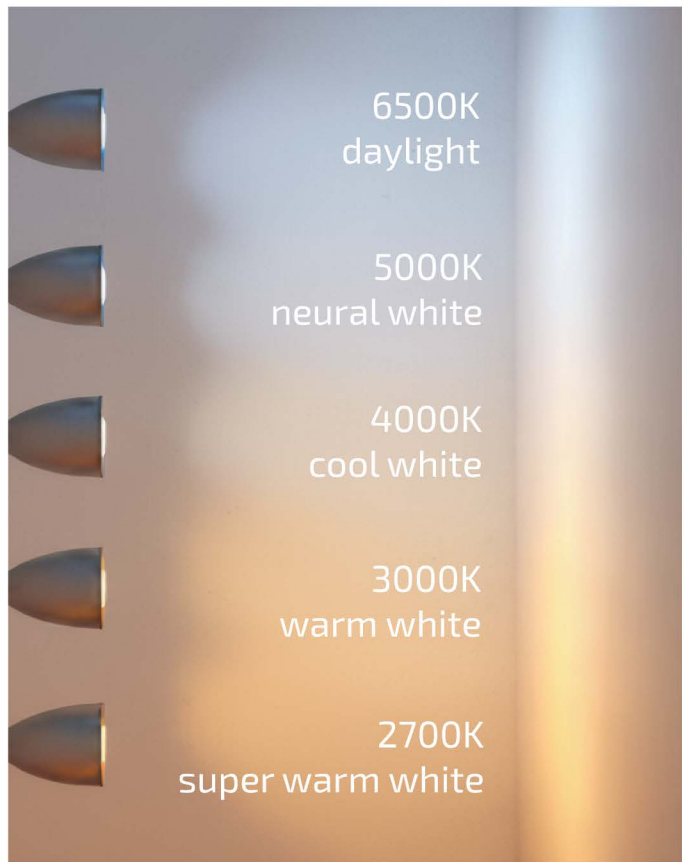

Easy guide to Colour Rendering Index (CRI)

you're looking at lamps, bulbs or any form of lights, you'll often notice how many products have a 'CRI' number, known as a 'Colour Rendering Index'. But what is 'CRI' and how does its rating effect our decision to make a purchase? Let BeamLED whittle down the facts for you in 'Your Guide to CRI'.

What is CRI?

CRI (Colour Rendering Index) is the standard measurement of a sources ability to reveal the colours of objects in comparison to a natural light source. The highest possible CRI is 100. This is the same colouring rendering as natural daylight which is often given to incandescent /halogen bulbs. The colour of the light is known as Correlated Colour Temperature (CC9) and is measured in Kelvin (K). Warmer/yellow bulbs = 3500K , whilst cooler/bluer bulbs = 6500K.

LUC 



DOWNLIGHT





LC-IB-SP-100

RECESSED DOWNLIGHT

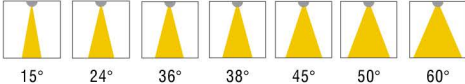

ADJUSTABLE/FIXED



- ▶ COB LED 
- ▶ Beam Angle 
- ▶ Mirror/Black/Gold cone 
- ▶ Honey comb is optional 
- ▶ IP20 
- ▶ IP65 with safety glass 

ORDERING INFORMATION

Example : LC-IB-SP-100-CT055-8W-30-ND

Model	Watts	CCT	Dimming
LC-IB-SP-100-XXXX-XX	XX	XX	XX
LC-IB-SP-100-CT055	8W	27 2700K	ND - Non Dim
LC-IB-SP-100-CT075-H69	10W	30 3000K	TD - Triac Dim
LC-IB-SP-100-CT075-H90	15W	35 3500K	VD - 0/1-10V Dim
LC-IB-SP-100-CT075-H117	25W	40 4000K	DA - DALI Dim
		50 5000K	
		57 5700K	
		65 6500K	

SPECIFICATION

Wattage	: 8W 10W 15W 25W
CRI	: 80 90
CCT	: 2700K 3000K 3500K 4000K 5000K 5700K 6500K
Beam	: 15° 24° 36° 38° 45° 50° 60°
Lumen	: 800 lm 1000 lm 1500 lm 2500 lm
Finish	: Matt white Trim Matt Black Trim
Material	: Die-casting alu. trim and heatsink, Glass
Driver	: Constant current remote LED driver included
Application	: Residential lighting, hotel and villas, bars, restaurants, etc.

DIMENSION (Unit mm.)

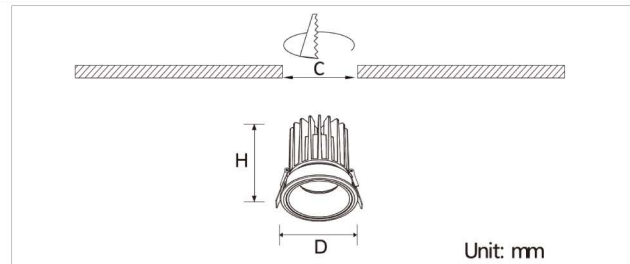

Unit: mm



Model	Watts	D×H(mm.)	Cutout (mm.)	Lumen(lm/w)	Beam Angle
LC-IB-SP-100-CT055	8W	Ø65×H76	Ø55	80-100	15° 24° 36° 50°
LC-IB-SP-100-CT075-H69	10W	Ø83×H69	Ø75	90-100	15° 24° 38° 45° 60°
LC-IB-SP-100-CT075-H90	15W	Ø83×H90	Ø75	90-100	15° 24° 38° 45° 60°
LC-IB-SP-100-CT075-H117	25W	Ø83×H117	Ø75	90-100	15° 24° 38° 45° 60°

Accessories

Reflector



Matt black

Mirror

Gun black

Golden

LC-IB-SP-101

RECESSED DOWNLIGHT



ADJUSTABLE/FIXED

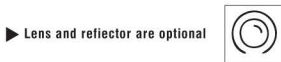
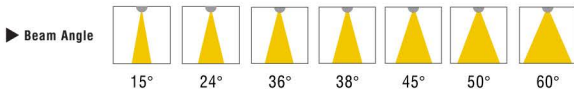

SPECIFICATION

Wattage	: 8W 10W 15W 25W 28W 40W
CRI	: 80 90
CCT	: 2700K 3000K 3500K 4000K 5000K 5700K 6500K
Beam	: 15° 24° 36° 38° 45° 50° 60°
Lumen	: 800 lm 1000 lm 1500 lm 2500 lm 2800 lm 4000 lm
Finish	: Matt White Trim Matt Black trim
Material	: Die-casting alu. trim and heatsink, Glass.
Driver	: Constant current remote LED driver included
Application	: Residential lighting, hotel and villas, bars, restaurants, etc.

DIMENSION (Unit mm.)

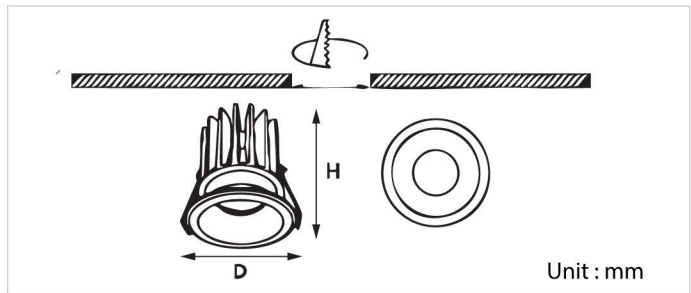

Model	Watts	D×H(mm.)	Cutout (mm.)	Lumen	Beam Angle
LC-IB-SP-101-CT055	8W	Ø65×H76	Ø55	80-100	15° 24° 36° 50°
LC-IB-SP-101-CT075-H74	10W	Ø85×H74	Ø75	90-100	15° 24° 38° 45° 60°
LC-IB-SP-101-CT075-H94	15W	Ø85×H94	Ø75	90-100	15° 24° 38° 45° 60°
LC-IB-SP-101-CT075-H122	25W	Ø85×H122	Ø75	90-100	15° 24° 38° 45° 60°
LC-IB-SP-101-CT095	28W	Ø105×H120	Ø95	90-100	15° 24° 38° 45° 60°
LC-IB-SP-101-CT095-H135	40W	Ø105×H120	Ø95	90-100	15° 24° 38° 45° 60°

ORDERING INFORMATION

Example : LC-IB-SP-101-CT055-8W-30-15D-ND

Model	Watts	CCT	Beam	Dimming
LC-IB-SP-101-XXXX-XXXX	XXX	XX	XX	XX
LC-IB-SP-101-CT055	8W	27 2700K	15°	ND - Non Dim
LC-IB-SP-101-CT075-H74	10W	30 3000K	24°	TD - Triac Dim
LC-IB-SP-101-CT075-H94	15W	35 3500K	38°	VD - 0/1-10V Dim
LC-IB-SP-101-CT075-H122	25W	40 4000K	36°	DA - DALI Dim
LC-IB-SP-101-CT095	28W	50 5000K	45°	
LC-IB-SP-101-CT095	28W	57 5700K	50°	
LC-IB-SP-101-CT095-H135	40W	65 6500K	60°	

LC-IB-SP-107

RECESSED ADJUSTABLE DOWNLIGHT



SPECIFICATION



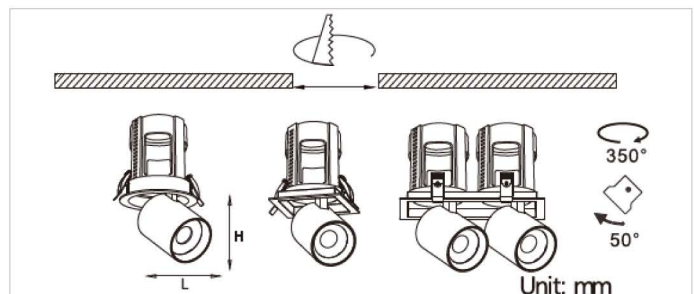

Wattage	: 15W 25W 2x15W 2x25W
CRI	: 80 90
CCT	: 2700K 3000K 3500K 4000K 5000K 5700K 6500K
Beam	: 15° 24° 38° 60°
Lumen	: 1500 lm 2500 lm 3000 lm 5000 lm
Finish	: Matt White Trim Matt Black Trim
Material	: Die-casting alu. trim and heatsink
Driver	: Constant current remote LED driver included
Application	: Shop

DIMENSION (Unit mm.)

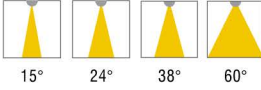

ADJUSTABLE/FIXED



- ▶ COB LED 
- ▶ Beam Angle 
- ▶ Glare Cut 40° 
- ▶ UGR < 17 
- ▶ Adjustable: horizontal 350° + vertical 50° 
- ▶ IP20 



Model	Watts	L×W×H(mm.)	Cutout (mm.)	Lumen
LC-IB-SP-107-CT095P	15W	Ø110×H120	Ø95	90-100
LC-IB-SP-107-CT115P	25W	Ø130×H140	Ø115	90-100
LC-IB-SP-107S-CT095P	15W	L110×W110×H120	L95xW95	90-100
LC-IB-SP-107S-CT115P	25W	L130×W130×H140	L115xW115	90-100
LC-IB-SP-107S-CT190P	2x15W	L210×W110×H120	L190xW95	90-100
LC-IB-SP-107S-CT230P	2x15W	L253×W130×H140	L230xW115	90-100

ORDERING INFORMATION

Example : LC-IB-SP-107S-CT095P-CGB-15W-30-15D-ND

Model	Watts	CCT	Beam	Dimming
LC-IB-SP-107S-CT095P	XXX	XX	XX	XX
LC-IB-SP-107-CT095P	15W	27 2700K	15°	ND - Non Dim
LC-IB-SP-107-CT115P	25W	30 3000K	24°	TD - Triac Dim
LC-IB-SP-107S-CT095P	2x15W	35 3500K	38°	VD - 0/1-10V Dim
LC-IB-SP-107S-CT115P	2x25W	40 4000K	60°	DA - DALI Dim
LC-IB-SP-107S-CT115P		50 5000K		
LC-IB-SP-107S-CT190P		57 5700K		
LC-IB-SP-107S-CT230P		65 6500K		





LC-IB-SP-110

RECESSED DOWNLIGHT

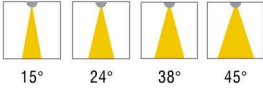

ADJUSTABLE/FIXED



- ▶ COB LED 
- ▶ Beam Angle 
- ▶ Lens and reflector are optional 
- ▶ IP65 with safety glass 
- ▶ UGR < 13 

SPECIFICATION

Wattage	: 10W 15W 25W
CRI	: 80 90
CCT	: 2700K 3000K 3500K 4000K 5000K 5700K 6500K
Beam	: 15° 24° 38° 45°
Lumen	: 1000 lm 1500 lm 2500 lm
Finish	: Matt White Trim Matt Black trim
Material	: Die-casting alu. trim and heatsink, Glass.
Driver	: Constant current remote LED driver included
Application	: Residential lighting, hotel and villas, bars, restaurants, etc.

DIMENSION (Unit mm.)

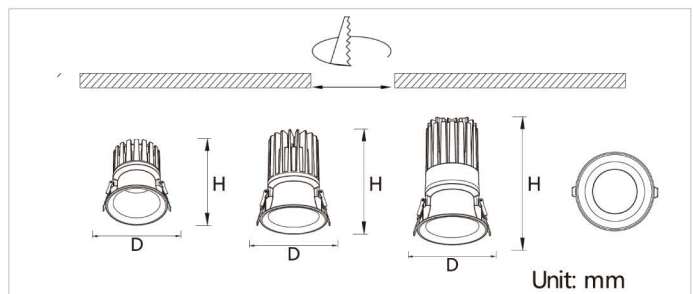

Model	Watts	D×H(mm.)	Cutout (mm.)	Lumen
LC-IB-SP-110-CT075-H92	10W	Ø85×H92	Ø75	70-90
LC-IB-SP-110-CT075-H113	15W	Ø85×H113	Ø75	70-90
LC-IB-SP-110-CT075-H139	25W	Ø85×H139	Ø75	70-90

ORDERING INFORMATION

Example : LC-IB-SP-110-CT075-H92-10W-30-15D-ND

Model	Watts	CCT	Beam	Dimming
LC-IB-SP-110-XXXX-XXX	XXX	XX	XX	XX
LC-IB-SP-110-CT075-H92	10W	27 2700K	15°	ND - Non Dim
LC-IB-SP-110-CT075-H113	15W	30 3000K	24°	TD - Triac Dim
LC-IB-SP-110-CT075-H139	25W	35 3500K	38°	VD - 0/1-10V Dim
		40 4000K	45°	DA - DALI Dim
		50 5000K		
		57 5700K		
		65 6500K		



LC-IB-SP-115

RECESSED DOWNLIGHT



ADJUSTABLE/FIXED

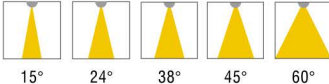

- ▶ COB LED 
- ▶ Beam Angle 
- ▶ Lens and reflector are optional 
- ▶ IP65 with safety glass 

SPECIFICATION

Wattage	: 10W 15W 25W
CRI	: 80 90
CCT	: 2700K 3000K 3500K 4000K 5000K 5700K 6500K
Beam	: 15° 24° 38° 45° 60°
Lumen	: 1000 lm 1500 lm 2500 lm
Finish	: Matt White Trim Matt Black Trim
Material	: Die-casting alu. trim and heatsink, Glass.
Driver	: Constant current remote LED driver included
Application	: Residential lighting, hotel and villas, bars, restaurants, etc.

DIMENSION (Unit mm.)

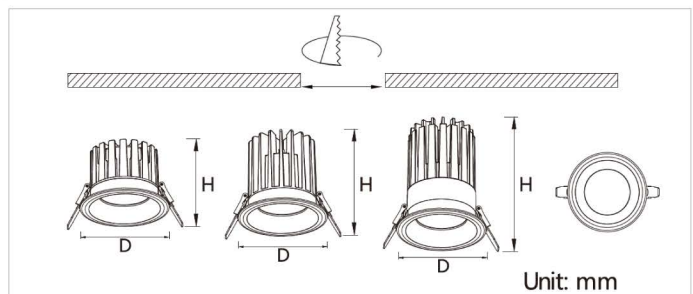

Model	Watts	D×H(mm.)	Cutout (mm.)	Lumen
LC-IB-SP-115-CT075-H57	10W	Ø83×H57	Ø75	90-100
LC-IB-SP-115-CT075-H78	15W	Ø83×H78	Ø75	90-100
LC-IB-SP-115-CT075-H105	25W	Ø83×H105	Ø75	90-100

ORDERING INFORMATION

Example : LC-IB-SP-115-CT075-H57-10W-30-15D-ND

Model	Watts	CCT	Beam	Dimming
LC-IB-SP-115-XXXX-XXX	XXX	XX	XX	XX
LC-IB-SP-115-CT075-H57	10W	27 2700K	15°	ND - Non Dim
LC-IB-SP-115-CT075-H78	15W	30 3000K	24°	TD - Triac Dim
LC-IB-SP-115-CT075-H105	25W	35 3500K	38°	VD - 0/1-10V Dim
		40 4000K	45°	DA - DALI Dim
		50 5000K	60°	
		57 5700K		
		65 6500K		







LC-IB-DL-125

RECESSED DOWNLIGHT



ADJUSTABLE/FIXED



- ▶ SMD2835 LED 
- ▶ Beam Angle  60°
- ▶ Pure aluminum optical reflector 
- ▶ UGR<13 
- ▶ IP20 
- ▶ IP65 with safety glass  

SPECIFICATION

- Wattage** : 18W | 28W | 38W | 48W
- CRI** : 80 | 90
- CCT** : 2700K | 3000K | 3500K | 4000K
5000K | 5700K | 6500K
- Beam** : 60°
- Lumen** : 1800 lm | 2800 lm | 3800 lm | 4500 lm
- Finish** : Matt White Trim | Matt Black Trim
- Material** : Die-casting alu. trim and heatsink, Glass
- Driver** : Constant current remote LED driver included
- Application** : Residential lighting, hotel and villas, bars, restaurants, etc.

DIMENSION (Unit mm.)

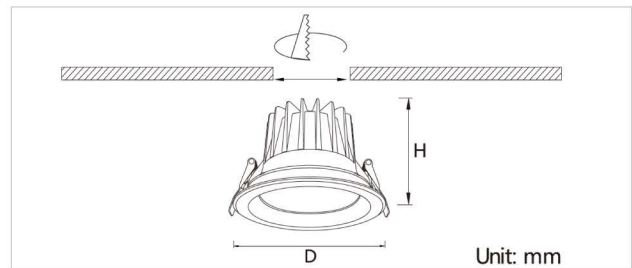

Model	Watts	D×H(mm.)	Cutout (mm.)	Lumen(lm/w)
LC-IB-DL-125-CT115	18W	Ø134×H97	Ø115	100-120
LC-IB-DL-125-CT140	28W	Ø160×H110	Ø140	100-120
LC-IB-DL-125-CT170	38W	Ø188×H129	Ø170	100-120
LC-IB-DL-125-CT200	48W	Ø227×H129	Ø200	100-120
LC-IB-DL-125-CT220	48W	Ø250×H149	Ø220	100-120

ORDERING INFORMATION

Example : LC-IB-DL-125-CT140-28W-30-60D-ND

Model	Watts	CCT	Beam	Dimming
LC-IB-DL-125-XXXXX	XXX	XX	XX	XX
LC-IB-DL-125-CT115	18W	27 2700K	60°	ND - Non Dim
LC-IB-DL-125-CT140	28W	30 3000K		TD - Triac Dim
LC-IB-DL-125-CT170	38W	35 3500K		VD - 0/1-10V Dim
LC-IB-DL-125-CT200	48W	40 4000K		DA - DALI Dim
LC-IB-DL-125-CT220		50 5000K		
		57 5700K		
		65 6500K		

LC-IB-DL-126

RECESSED DOWNLIGHT

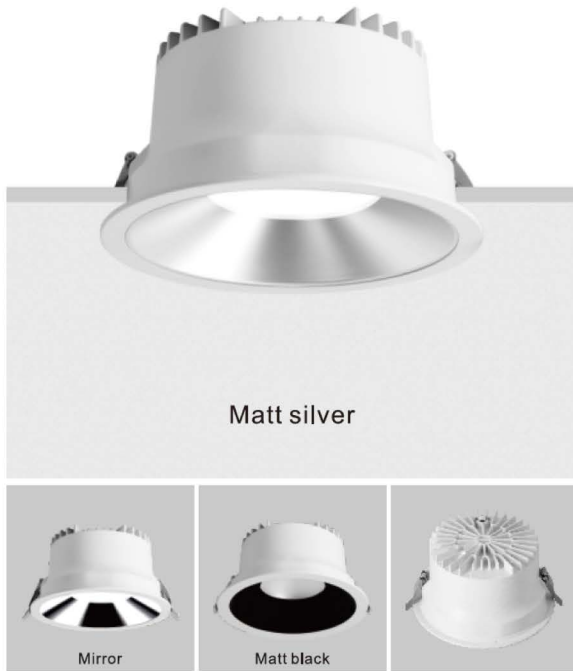

ADJUSTABLE/FIXED

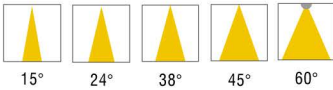

▶ SMD2835 LED  ▶ Up to 130 lm/w @ CRI.90 

▶ Beam Angle 
15° | 24° | 38° | 45° | 60°

▶ Finish 

▶ IP20 

SPECIFICATION

Wattage : 15W | 25W | 35W
CRI : 80 | 90
CCT : 2700K | 3000K | 3500K | 4000K
 5000K | 5700K | 6500K
Beam : 15° | 24° | 38° | 45° | 60°
Lumen : 1500 lm | 2500 lm | 3500 lm
Finish : Matt White | Matt Black
Material : Die-casting alu. trim and heatsink, PC.Diffuser
Driver : Constant current remote LED driver included
Application : Residential lighting, hotel and villas, bars, restaurants, etc.

DIMENSION (Unit mm.)

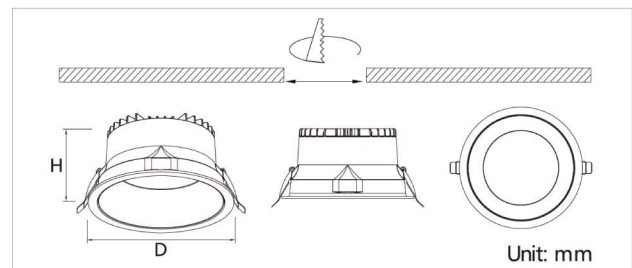

Model	Watts	D×H(mm.)	Cutout (mm.)	Lumen(lm/w)	Beam Angle
LC-IB-DL-126-CT090	15W	Ø104×H77	Ø90-95	100-120	15° 24° 38° 60°
LC-IB-DL-126-CT155	25W	Ø170×H90	Ø153-160	110-130	15° 24° 38° 45° 60°
LC-IB-DL-126-CT200	35W	Ø225×H110	Ø195-210	110-150	15° 24° 38° 45° 60°

Accessories

Reflector

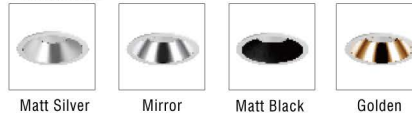

ORDERING INFORMATION

Example : LC-IB-DL-126-CT090-15W-30-15D-ND

Model	Watts	CCT	Dimming
LC-IB-DL-126-XXXXX	XXX	XX	XX
LC-IB-DL-126-CT090	15W	27 2700K	ND - Non Dim
LC-IB-DL-126-CT155	25W	30 3000K	TD - Triac Dim
LC-IB-DL-126-CT200	35W	35 3500K	VD - 0/1-10V Dim
		40 4000K	DA - DALI Dim
		50 5000K	
		57 5700K	
		65 6500K	

LC-IB-DL-127

RECESSED DOWNLIGHT



Matt silver

Mirror

Matt black

ADJUSTABLE/FIXED



SPECIFICATION

Wattage	: 15W 25W 35W
CRI	: 80 90
CCT	: 2700K 3000K 3500K 4000K 5000K 5700K 6500K
Beam	: 60°
Lumen	: 1500 lm 2500 lm 3500 lm
Finish	: Matt White Matt Black
Material	: Die-casting alu. trim and heatsink, PC.Diffuser
Driver	: Constant current remote LED driver included
Application	: Residential lighting, hotel and villas, bars, restaurants, etc.

DIMENSION (Unit mm.)

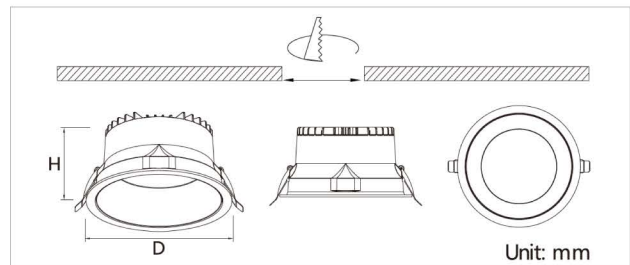

Model	Watts	D×H(mm.)	Cutout (mm.)	Lumen(lm/w)	Beam Angle
LC-IB-DL-127-CT090	15W	Ø104×H77	Ø90-95	100-130	60°
LC-IB-DL-127-CT155	25W	Ø170×H90	Ø153-160	100-150	60°
LC-IB-DL-127-CT200	35W	Ø225×H110	Ø195-210	100-150	60°

Accessories

Reflector

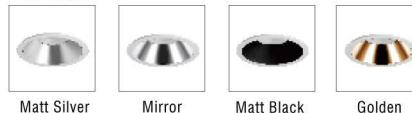

ORDERING INFORMATION

Example : LC-IB-DL-127-CT090-15W-30-60D-ND

Model	Watts	CCT	Dimming
LC-IB-DL-127-XXXXX	XXX	XX	XX
LC-IB-DL-127-CT090	15W	27 2700K	ND - Non Dim
LC-IB-DL-127-CT155	25W	30 3000K	TD - Triac Dim
LC-IB-DL-127-CT200	35W	35 3500K	VD - 0/1-10V Dim
		40 4000K	DA - DALI Dim
		50 5000K	
		57 5700K	
		65 6500K	

LC-IB-SP-135

RECESSED DOWNLIGHT

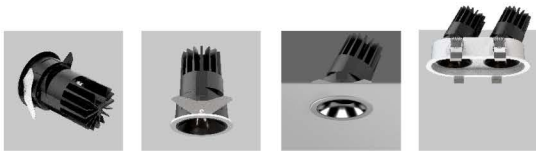

SPECIFICATION

Wattage	: 8W 18W 25W 2×8W 2×18W 2×25W
CRI	: 80 90
CCT	: 2700K 3000K 3500K 4000K 5000K 5700K 6500K
Beam	: 15° 24° 38° 60°
Lumen	: 800 lm 1800 lm 1600lm 2500lm 3600lm 5000lm
Finish	: Matt white or black trim
Material	: Die-casting alu. trim and heatsink, PMMA. lens
Driver	: Constant current remote LED driver included
Application	: Residential lighting, hotel and villas, bars, restaurants, etc.

ADJUSTABLE/FIXED

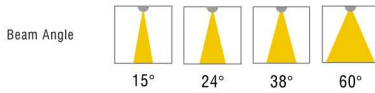
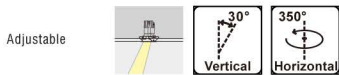

DIMENSION (Unit mm.)

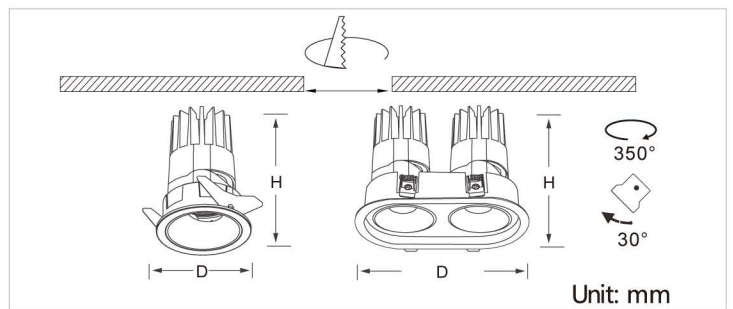

Model	Watts	D×H(mm.)	Cutout (mm.)
LC-IB-SP-135-CT005	8W	Ø62×H85mm.	Ø55 mm.
LC-IB-SP-135-CT075	18W	Ø84×H110mm.	Ø75 mm.
LC-IB-SP-135-CT095	25W	Ø105×H 130mm.	Ø95 mm.
LC-IB-SP-135-CT055-2H	2×8W	Ø139×79×H90mm.	L128×Ø65 mm.
LC-IB-SP-135-CT075-2H	2×18W	Ø194×105×H120mm.	L180×Ø95 mm.
LC-IB-SP-135-CT095-2H	2×25W	Ø239×125×H142mm.	L225×Ø110 mm.

Accessories

Reflector



ORDERING INFORMATION

Example : LC-IB-SP-135-CT005-CGB-8W-30-15D-ND

Model	Reflector	Watts	CCT	Beam	Dimming
LC-IB-SP-135-XXXXX	XXX	XX	XX	XX	XX
LC-IB-SP-135-CT005	<CGB> Gun black	8W	27 2700K	15°	ND Non Dim
LC-IB-SP-135-CT075	<CM> Mirror	18W	30 3000K	24°	TD Triac Dim
LC-IB-SP-135-CT095	<CW> 1 Matt white	25W	35 3500K	38°	VD 0/1-10V Dim
LC-IB-SP-135-CT055-2H	<CB> Matt black	2×8W	40 4000K	60°	DA DALI Dim
LC-IB-SP-135-CT075-2H	<CS> Matt silver	2×18W	50 5000K		
LC-IB-SP-135-CT095-2H	<CG> Golden	2×25W	57 5700K		
			65 6500K		

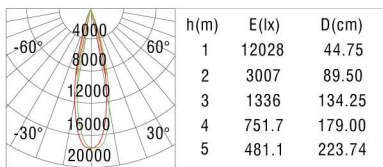

LC-IB-SP-135S

RECESSED DOWNLIGHT



SPECIFICATION



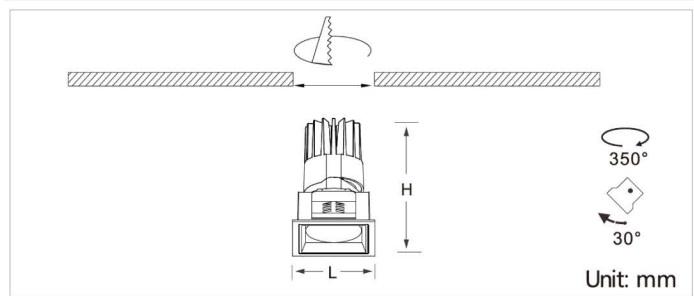

Wattage	: 8W 18W 25W
CRI	: 80 90
CCT	: 2700K 3000K 3500K 4000K 5000K 5700K 6500K
Beam	: 15° 24° 38° 60°
Finish	: Matt white or black trim
Material	: Die-casting alu. trim and heatsink
Driver	: Constant current remote LED driver included
Application	: Residential lighting, hotel and villas, bars, restaurants, etc.

DIMENSION (Unit mm.)

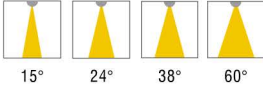

ADJUSTABLE/FIXED



- ▶ COB LED 
- ▶ Beam Angle 
- ▶ Lens and reflector are optional 
- ▶ Honey comb is optional 
- ▶ Adjustable: horizontal 350° + vertical 30° 
- ▶ IP65 with safety glass 



Model	Watts	L×W×H(mm.)	Cutout (mm.)	Lumen
LC-IB-SP-135S-CT055	8W	L64×W64×H93	L55×W55	65-85
LC-IB-SP-135S-CT075	18W	L85×W85×H120	L75×W75	70-90
LC-IB-SP-135S-CT095	25W	L105×W105×H146	L95×W95	70-90

Accessories

Reflector



ORDERING INFORMATION

Example LC-IB-SP-135S-CT055-CGB-8W-30-15D-ND

Model	Reflector	Watts	CCT	Beam	Dimming
LC-IB-SP-135S-XXXXX	XXX	XX	XX	XX	XX
LC-IB-SP-135S-CT055	<CGB> Gun black	8W	27 2700K 30 3000K	15°	ND Non Dim
LC-IB-SP-135S-CT075	<CM> Mirror	18W	35 3500K 40 4000K	24° 38°	TD Triac Dim VD 0/1-10V Dim
LC-IB-SP-135S-CT095	<CW> Matt white <CB> Matt black <CS> Matt silver <CG> Golden	25W	50 5000K 57 5700K 65 6500K	60°	DA DALI Dim

LC-IB-SP-135S-2H

RECESSED DOWNLIGHT



SPECIFICATION

Wattage	: 2x8W 2x18W 2x25W
CRI	: 80 90
CCT	: 2700K 3000K 3500K 4000K 5000K 5700K 6500K
Beam	: 15° 24° 38° 60°
Finish	: Matt white or black trim
Material	: Die-casting alu. trim and heatsink
Driver	: Constant current remote LED driver included
Application	: Residential lighting, hotel and villas, bars, restaurants, etc.

DIMENSION (Unit mm.)

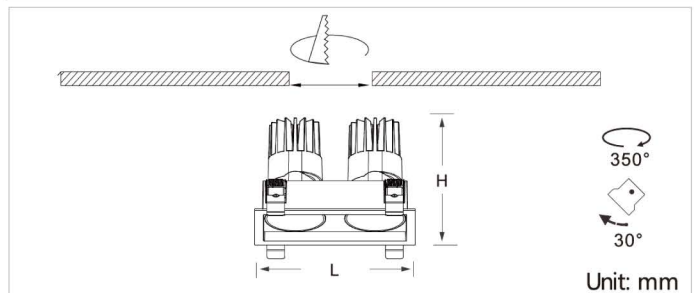

ADJUSTABLE/FIXED



- ▶ COB LED
- ▶ Beam Angle
- ▶ Lens and reflector are optional
- ▶ Honey comb is optional
- ▶ Adjustable: horizontal 350° + vertical 30°
- ▶ IP65 with safety glass



Model	Watts	L×W×H(mm.)	Cutout (mm.)	Lumen
LC-IB-SP-135S-CT055-2H	2x8W	L130×W69×H90	L120×W60	65-85
LC-IB-SP-135S-CT075-2H	2x18W	L180×W90×H120	L165×W80	70-90
LC-IB-SP-135S-CT095-2H	2x25W	L224×W110×H142	L210×W100	70-90

Multi-Trim Options : 2-Head, 3-Head, 4-Head



Accessories

Reflector



ORDERING INFORMATION

Example LC-IB-SP-135S-CT055-2H-CGB-8W-30-15D-ND

Model	Reflector	Watts	CCT	Beam	Dimming
LC-IB-SP-135S-XXXX-XX	XXX	XXXX	XX	XX	XX
LC-IB-SP-135S-CT055-2H	<CGB> Gun black	2x8W	27 2700K	15°	ND Non Dim
LC-IB-SP-135S-CT075-2H	<CM> Mirror	2x18W	30 3000K	24°	TD Triac Dim
LC-IB-SP-135S-CT095-2H	<CW> Matt white	2x25W	35 3500K	38°	VD 0/1-10V Dim
	<CB> Matt black		40 4000K		
	<CS> Matt silver		50 5000K		
	<CG> Golden		57 5700K		
			65 6500K		

LC-IB-SP-135-PRO

RECESSED DOWNLIGHT



SPECIFICATION



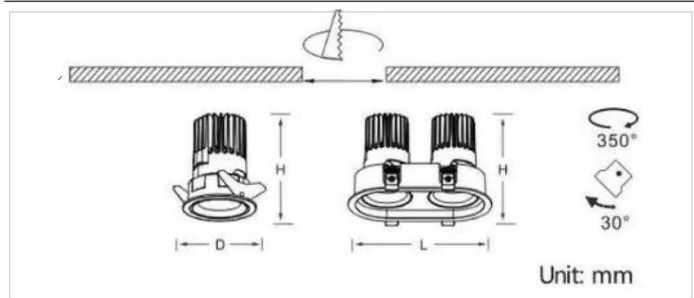

Wattage	: 10W 2x10W 2x20W 28W 2x28W
CRI	: 80 90
CCT	: 2700K 3000K 3500K 4000K 5000K 5700K 6500K
Beam	: 15° 24° 36° 55°
Finish	: Matt white or black trim
Material	: Die-casting alu. trim and heatsink
Driver	: Constant current remote LED driver included
Application	: Residential lighting, hotel and villas, bars, restaurants, etc.

DIMENSION (Unit mm.)

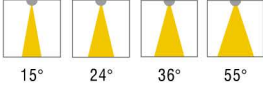

ADJUSTABLE/FIXED



- ▶ COB LED 
- ▶ Beam Angle 
- ▶ Lens and reflector are optional 
- ▶ Honey comb is optional 
- ▶ Adjustable: horizontal 350° + vertical 30° 



Model	Watts	L×W×H(mm.)	Cutout (mm.)	Lumen
LC-IB-SP-135-CT055-PRO	10W	Ø62×H90	Ø55	70-80
LC-IB-SP-135-CT055-2H-PRO	2x10W	L140×W79×H95	L128×Ø67	70-80
LC-IB-SP-135-CT075-PRO	20W	Ø85×H110	Ø75	90-105
LC-IB-SP-135-CT075-2H-PRO	2x20W	L194×W104×H121	L179×Ø91	90-105
LC-IB-SP-135-CT095-PRO	28W	Ø105×H130	Ø95	90-105
LC-IB-SP-135-CT095-2H-PRO	2x28W	L239×W125×H142	L223×Ø112	90-105

Accessories

Reflector



ORDERING INFORMATION

Example LC-IB-SP-135-CT055-PRO-CW-10W-30-15D-ND

Model	Reflector	Watts	CCT	Beam	Dimming
LC-IB-SP-135-XXXX-XXX	XX	XXX	XX	XX	XX
LC-IB-SP-135-CT055-PRO	<CW> Matt white	10W	27 2700K 30 3000K	15°	ND Non Dim
LC-IB-SP-135-CT055-2H-PRO	<CB> Matt Black	2x10W	35 3500K	24°	TD Triac Dim
LC-IB-SP-135-CT075-PRO		20W	40 4000K	36°	VD 0/1-10V Dim
LC-IB-SP-135-CT075-2H-PRO		2x20W	50 5000K	60°	DA DALI Dim
LC-IB-SP-135-CT095-PRO		28W	57 5700K		
LC-IB-SP-135-CT095-2H-PRO		2x28W	65 6500K		

LC-IB-SP-135S-PRO

RECESSED DOWNLIGHT



SPECIFICATION

Wattage	: 10W 20W 28W
CRI	: 80 90
CCT	: 2700K 3000K 3500K 4000K 5000K 5700K 6500K
Beam	: 15° 24° 36° 55°
Finish	: Matt white or black trim
Material	: Die-casting alu. trim and heatsink
Driver	: Constant current remote LED driver included
Application	: Residential lighting, hotel and villas, bars, restaurants, etc.





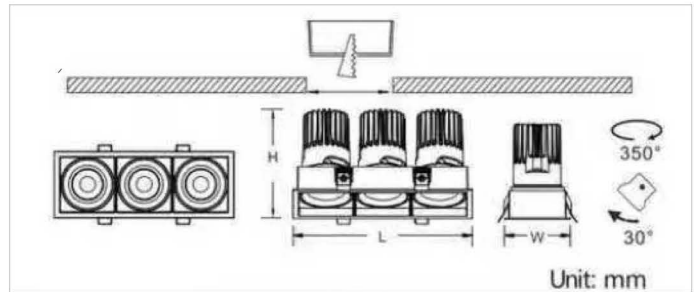

DIMENSION (Unit mm.)



ADJUSTABLE/FIXED

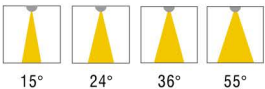

- ▶ COB LED  ▶ Adjustable: horizontal 350°+vertical 30° 
- ▶ Lens and reflector are optional  ▶ Honey comb is optional 
- ▶ Beam Angle  15° | 24° | 36° | 55°



Model	Watts	L×W×H(mm.)	Cutout (mm.)	Lumen
LC-IB-SP-135S-CT055-PRO	10W	L64×W64×H98	L55×W55	70-80
LC-IB-SP-135S-CT055-2H-PRO	2x10W	L118×W65×H98	L110×W57	70-80
LC-IB-SP-135S-CT055-3H-PRO	3x10W	L170×W65×H98	L162×W57	70-80
LC-IB-SP-135S-CT055-4H-PRO	4x10W	L225×W65×H98	L218×W57	70-80
LC-IB-SP-135S-CT075-PRO	20W	L85×W85×H121	L75×W75	90-105
LC-IB-SP-135S-CT075-2H-PRO	2x20W	L157×W85×H121	L148×W76	90-105
LC-IB-SP-135S-CT075-3H-PRO	3x20W	L229×W85×H121	L221×W76	90-105
LC-IB-SP-135S-CT075-4H-PRO	4x20W	L303×W85×H121	L295×W76	90-105
LC-IB-SP-135S-CT095-PRO	28W	L105×W105×H146	L95×W95	90-105
LC-IB-SP-135S-CT095-2H-PRO	2x28W	L197×W105×H146	L188×W96	90-105
LC-IB-SP-135S-CT095-3H-PRO	3x28W	L290×W105×H146	L281×W96	90-105
LC-IB-SP-135S-CT095-4H-PRO	4x28W	L383×W105×H146	L375×W96	90-105

Accessories

Reflector



ORDERING INFORMATION

Example LC-IB-SP-135S-CT055-PRO-CW-10W-30-15D-ND

Model	Reflector	Watts	CCT	Beam	Dimming
LC-IB-SP-135S-XXXX-XXX	XX	XXX	XX	XX	XX
LC-IB-SP-135S-CT055-PRO	<CW> Matt white	10W	27 2700K	15°	ND Non Dim
LC-IB-SP-135S-CT055-2H-PRO	<CB> Matt Black	2x10W	30 3000K	24°	TD Triac Dim
LC-IB-SP-135S-CT055-3H-PRO		3x10W	35 3500K	36°	VD 0/1-10V Dim
LC-IB-SP-135S-CT055-4H-PRO		4x10W	40 4000K	60°	DA DALI Dim
LC-IB-SP-135S-CT075-PRO		20W	50 5000K		
LC-IB-SP-135S-CT075-2H-PRO		2x20W	57 5700K		
LC-IB-SP-135S-CT075-3H-PRO		3x20W	65 6500K		
LC-IB-SP-135S-CT075-4H-PRO		4x20W			
LC-IB-SP-135S-CT095-PRO		28W			
LC-IB-SP-135S-CT095-2H-PRO		2x28W			
LC-IB-SP-135S-CT095-3H-PRO		3x28W			
LC-IB-SP-135S-CT095-4H-PRO		4x28W			



LC-IB-SP-138

RECESSED DOWNLIGHT



ADJUSTABLE/FIXED

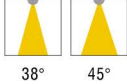

- ▶ COB LED 
- ▶ Beam Angle 
 - 38°
 - 45°
- ▶ Lens and reflector are optional 
- ▶ IP65 with safety glass 

SPECIFICATION

Wattage	: 10W 15W 25W
CRI	: 80 90
CCT	: 2700K 3000K 3500K 4000K 5000K 5700K 6500K
Beam	: 38° 45°
Lumen	: 1000 lm 1500 lm 2500 lm
Finish	: Matt white or black trim
Material	: Die-casting alu. trim and heatsink, Glass.
Driver	: Constant current remote LED driver included
Application	: Residential lighting, hotel and villas, bars, restaurants, etc.

DIMENSION (Unit mm.)

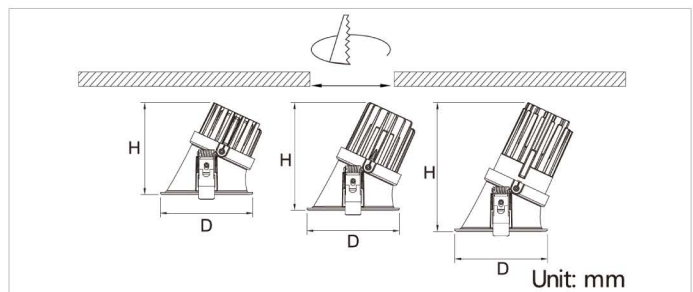

Model	Watts	D×H(mm.)	Cutout (mm.)
LC-IB-SP-138-CT095-H104	10W	Ø105×H104	Ø95
LC-IB-SP-138-CT095-H122	15W	Ø105×H122	Ø95
LC-IB-SP-138-CT095-H146	25W	Ø105×H146	Ø95

ORDERING INFORMATION

Example : LC-IB-SP-138-CT095-H122-10W-30-38D-ND

Model	Watts	CCT	Beam	Dimming
LC-IB-SP-138-XXXX-XXX	XXX	XX	XX	XX
LC-IB-SP-138-CT095-H104	10W	27 2700K	38°	ND Non Dim
LC-IB-SP-138-CT095-H122	15W	30 3000K	45°	TD Triac Dim
LC-IB-SP-138-CT095-H146	25W	35 3500K		VD 0/1-10V Dim
		40 4000K		DA DALI Dim
		50 5000K		
		57 5700K		
		65 6500K		

LC-IB-DL-141

RECESSED DOWNLIGHT



SPECIFICATION



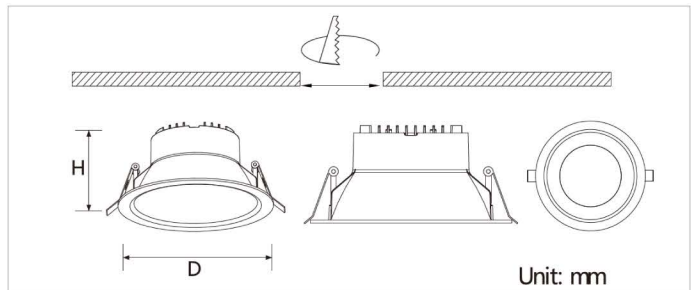

Wattage	: 15W 25W 35W
CRI	: 80 90
CCT	: 2700K 3000K 3500K 4000K 5000K 5700K 6500K
Beam	: 90°
Finish	: Matt white or black trim
Material	: Aluminum body and PC diffuser
Driver	: Constant current remote LED driver included
Application	: Residential lighting, hotel and villas, bars, restaurants, etc.

DIMENSION (Unit mm.)



ADJUSTABLE/FIXED



- ▶ SMD2835 
- ▶ Beam Angle  90°
- ▶ Glare cut-pf 40° 
- ▶ Fixed 
- ▶ Finish 



Model	Watts	D×H(mm.)	Cutout (mm.)	Lumen
LC-IB-DL-141-CT110	15W	Ø130×H82	Ø110	90-100
LC-IB-DL-141-CT165	25W	Ø180×H87	Ø165	90-100
LC-IB-DL-141-CT200	35W	Ø220×H94	Ø195	100-110

ORDERING INFORMATION

Example : LC-IB-DL-141-CT110-15W-30-ND

Model	Watts	CCT	Dimming
LC-IB-DL-141-XXXXX	XXX	XX	XX
LC-IB-DL-141-CT110	15W	27 2700K	ND Non Dim
LC-IB-DL-141-CT165	25W	30 3000K	TD Triac Dim
LC-IB-DL-141-CT200	35W	35 3500K	VD 0/1-10V Dim
		40 4000K	DA DALI Dim
		50 5000K	
		57 5700K	
		65 6500K	

LC-IB-SP-153

RECESSED DOWNLIGHT



ADJUSTABLE/FIXED

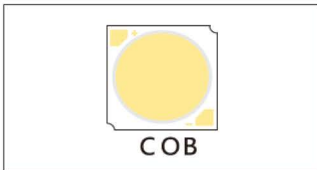

Ra>80

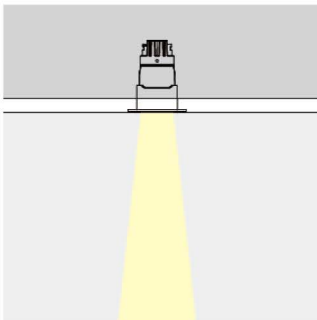

SPECIFICATION

Wattage	: 10W
CRI	: 80 90
CCT	: 2700K 3000K 3500K 4000K 5000K 5700K 6500K
Beam	: 15° 24° 38°
Lumen	: 900 lm
Finish	: white black
Material	: Die-casting alu. trim and heatsink
Driver	: Constant current remote LED driver included
Application	: Residential lighting, hotel and villas, bars, restaurants, etc.

DIMENSION (Unit mm.)

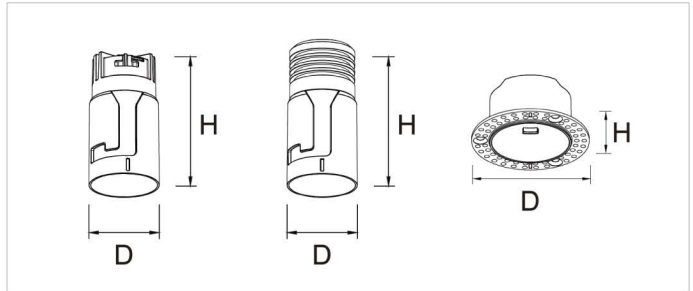

Model	Watts	D×H(mm.)	Cutout (mm.)	Lumen
LC-IB-SP-153-CT050-H92	10W	Ø45×H92	/	65-85
LC-153-CT050-TL	/	Ø70×H35	Ø50	/
LC-153-CT055	/	Ø65×H33	Ø55	/

LC-IB-SP-155

RECESSED DOWNLIGHT



SPECIFICATION

Wattage	: 8W 15W
CRI	: 80 90
CCT	: 2700K 3000K 3500K 4000K 5000K 5700K 6500K
Beam	: 15° 24° 36° 50°
Lumen	: 640 lm 1200 lm
Finish	: Matt white or black trim
Material	: Die-casting alu. trim and heatsink, PMMA. lens
Driver	: Constant current remote LED driver included
Application	: Residential lighting, hotel and villas, bars, restaurants, etc.

Adjustable/Fixed

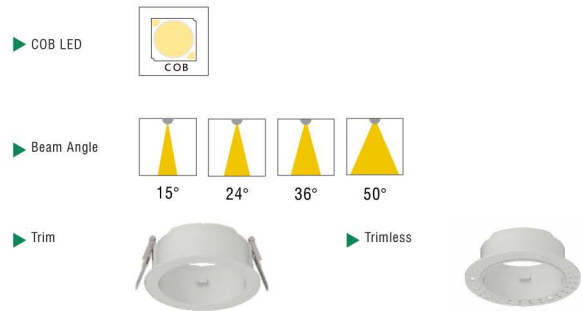

DIMENSION (Unit mm.)

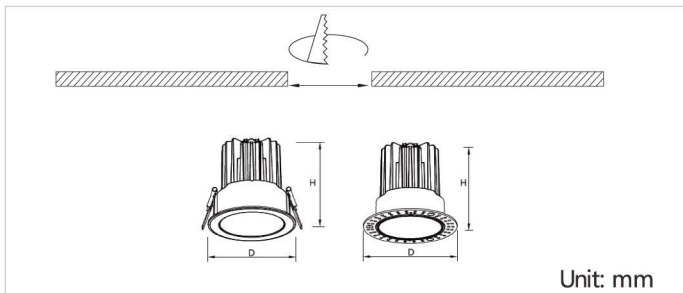

24° 20W 3000K	Beam Angle	h(m)	E(lx)	D(cm)
	15°	1.300	398.5	45.13
	24°	2.600	996.2	90.27
	36°	3.900	442.8	135.4
	50°	5.200	249.1	180.5
	6500	6.500	159.4	225.6

Model	Watts	D×H(mm.)	Cutout (mm.)
LC-IBSP-155CT85H95	8W	Ø93×H95mm.	Ø85 mm.
LC-IBSP-155CT85H99	15W	Ø93×H99mm.	Ø85 mm.
LC-IBSP-155CT75H95-TL	8W	Ø101×H95mm.	Ø75 mm.
LC-IBSP-155CT75H99-TL	15W	Ø101×H99mm.	Ø75 mm.

Accessories

Reflector

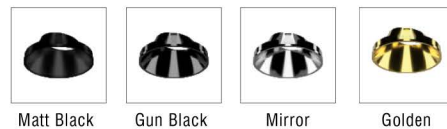

ORDERING INFORMATION

Example : LC-IBSP-155CT85H95-8W-30-15D-ND

Model	Watts	CCT	Beam	Dimming
LC-IBSP-155XXXXXX	XX	XX	XX	XX
LC-IBSP-155CT85H95	8W	27 2700K	15°	ND Non Dim
LC-IBSP-155CT85H99	15W	30 3000K	24°	TD Triac Dim
LC-IBSP-155CT75H95-TL		35 3500K	36°	VD 0/1-10V Dim
LC-IBSP-155CT75H99-TL		40 4000K	50°	DA DALI Dim
		50 5000K		
		57 5700K		
		65 6500K		

LC-IB-SP-156

RECESSED DOWNLIGHT



SPECIFICATION

Wattage	: 10W 15W 25W
CRI	: 80 90
CCT	: 2700K 3000K 3500K 4000K 5000K 5700K 6500K
Beam	: 15° 24° 38° 45° 60°
Lumen	: >900 lm 1350 2250 lm
Finish	: Matt white or black trim
Material	: Die-casting alu. trim and heatsink, PMMA. lens
Driver	: Constant current remote LED driver included
Application	: Residential lighting, hotel and villas, bars, restaurants, etc.

Adjustable/Fixed



▶ Adjustable



▶ COB LED



▶ Beam Angle

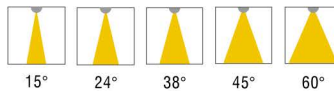

▶ Trim



▶ Trimless



DIMENSION (Unit mm.)

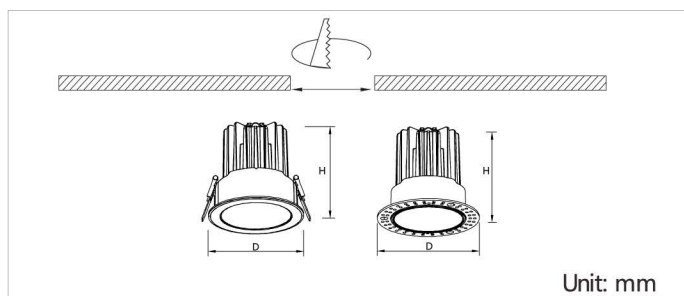

Unit: mm

Model	Watts	D×H(mm.)	Cutout (mm.)
LC-IBSP-156CT085H69	10W	Ø93×H69mm.	Ø85 mm.
LC-IBSP-156CT085H89	15W	Ø93×H89mm.	Ø85 mm.
LC-IBSP-156CT085H116	25W	Ø93×H116mm.	Ø85 mm.
LC-IBSP-156CT075H69-TL	10W	Ø101×H69mm.	Ø75 mm.
LC-IBSP-156CT075H89-TL	15W	Ø101×H89mm.	Ø75 mm.
LC-IBSP-156CT075H116-TL	25W	Ø101×H116mm.	Ø75 mm.

Accessories

Reflector



Matt Black



Gun Black



Mirror



Golden

Honey Comb Louver



ORDERING INFORMATION

Example : LC-IBSP-156CT85H69-8W-30-15D-ND

Model	Watts	CCT	Beam	Dimming
LC-IBSP-156XXXXXXX	XX	XX	XX	XX
LC-IBSP-156CT085H69	10W	27 2700K	15°	ND Non Dim
LC-IBSP-156CT085H89	15W	30 3000K	24°	TD Triac Dim
LC-IBSP-156CT085H116	25W	35 3500K	38°	VD 0/1-10V Dim
LC-IBSP-156CT075H69-TL		40 4000K	50°	DA DALI Dim
LC-IBSP-156CT075H89-TL		57 5700K	60°	
LC-IBSP-156CT075H116-TL		65 6500K		

LC-IB-SP-158-OV1

RECESSED DOWNLIGHT



ADJUSTABLE/FIXED



► COB LED

► Beam Angle

► Lens and reflector are optional

► Honey comb is optional

► IP65 with safety glass

► Adjustable : horizontal 280°+vertical 30°

Trim Trimless

SPECIFICATION

Wattage	: 8W 15W
CRI	: 80 90
CCT	: 2700K 3000K 3500K 4000K 5000K 5700K 6500K
Beam	: 15° 24° 36°
Lumen	: 800 lm 1500 lm
Finish	: Matt white or black trim
Material	: Die-casting alu. trim and heatsink
Driver	: Constant current remote LED driver included
Application	: Residential lighting, hotel and villas, bars, restaurants, etc.

DIMENSION (Unit mm.)

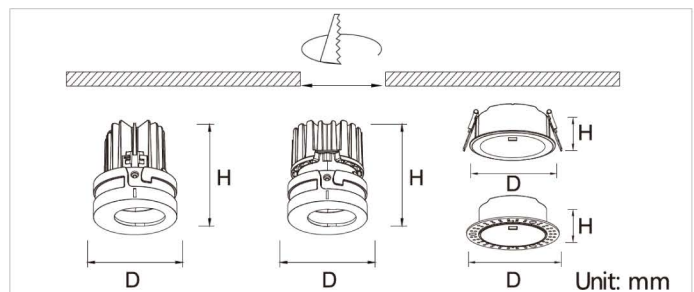

Model	Watts	D×H(mm.)	Cutout (mm.)	Lumen
LC-IB-SP-158-CT085-H81-OV1	8W	Ø70×H81	/	75-85
LC-IB-SP-158-CT085-H85-OV1	15W	Ø70×H85	/	75-85
155-CT085	trim	Ø93×H36	Ø85	/
155-CT075-TL	trim	Ø101×H33	Ø75	/

ORDERING INFORMATION

Example : LC-IB-SP-158-CT085-H81-OV1-8W-30-15D-ND

Model	Watts	CCT	Beam	Dimming
LC-IB-SP-158-CT085-XXX-OV1	XX	XX	XX	XX
LC-IB-SP-158-CT085-H81-OV1	8W	27 2700K	15°	ND Non Dim
LC-IB-SP-158-CT085-H85-OV1	15W	30 3000K	24°	TD Triac Dim
		35 3500K	36°	VD 0/1-10V Dim
		40 4000K		DA DALI Dim
		50 5000K		
		57 5700K		
		65 6500K		

LC-IB-SP-158-PIN

RECESSED DOWNLIGHT

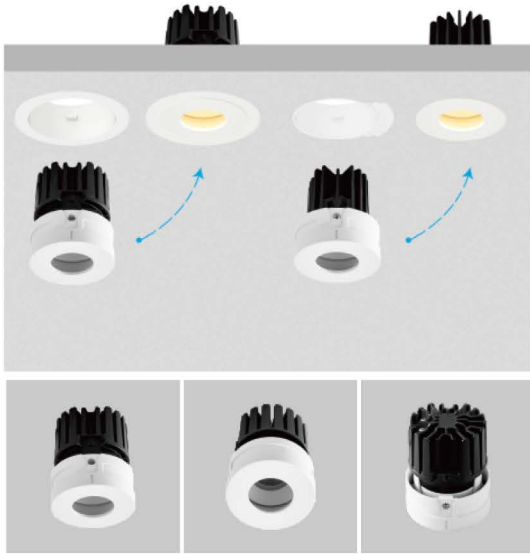

ADJUSTABLE/FIXED



- ▶ COB LED
- ▶ Beam Angle
- ▶ Lens and reflector are optional
- ▶ Honey comb is optional
- ▶ IP65 with safety glass

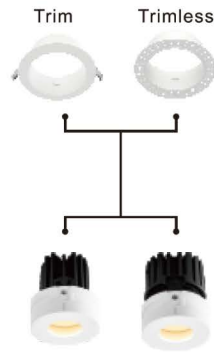

SPECIFICATION

Wattage	: 8W 15W
CRI	: 80 90
CCT	: 2700K 3000K 3500K 4000K 5000K 5700K 6500K
Beam	: 15° 24° 36°
Lumen	: 800 lm 1500 lm
Finish	: Matt white or black trim
Material	: Die-casting alu. trim and heatsink
Driver	: Constant current remote LED driver included
Application	: Residential lighting, hotel and villas, bars, restaurants, etc.

DIMENSION (Unit mm.)

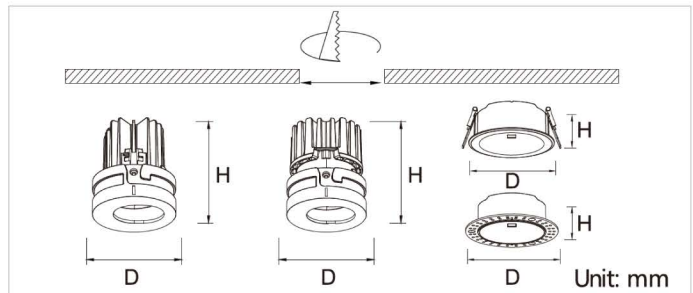

Model	Watts	D×H(mm.)	Cutout (mm.)	Lumen
LC-IB-SP-158-CT085-H81-PIN	8W	Ø70×H81	/	65-85
LC-IB-SP-158-CT085-H85-PIN	15W	Ø70×H85	/	65-85
155-CT085	trim	Ø93×H36	Ø85	/
155-CT075-TL	trim	Ø101×H33	Ø75	/

ORDERING INFORMATION

Example : LC-IB-SP-158-CT085-H81-8W-30-15D-ND

Model	Watts	CCT	Beam	Dimming
LC-IB-SP-158-CT085-XXX-PIN	XX	XX	XX	XX
LC-IB-SP-158-CT085-H81-PIN	8W	27 2700K	15°	ND Non Dim
LC-IB-SP-158-CT085-H85-PIN	15W	30 3000K	24°	TD Triac Dim
		35 3500K	36°	VD 0/1-10V Dim
		40 4000K		DA DALI Dim
		50 5000K		
		57 5700K		
		65 6500K		

LC-IB-SP-221

RECESSED DOWNLIGHT



FIXED



- ▶ COB LED
- ▶ Beam Angle
- ▶ Cutout Ø42 mm
- ▶ Fixed

SPECIFICATION

- Wattage** : 3-7W
- CRI** : 80 | 90
- CCT** : 2700K | 3000K | 3500K | 4000K
5000K | 5700K | 6500K
- Beam** : 15° | 24° | 36° | 38° | 50°
- Lumen** : 300 - 700 lm
- Finish** : Matt white or black trim
- Material** : Die-casting alu. trim and heatsink
- Driver** : Constant current remote LED driver included
- Application** : Residential lighting, hotel and villas, bars, restaurants, etc.

DIMENSION (Unit mm.)

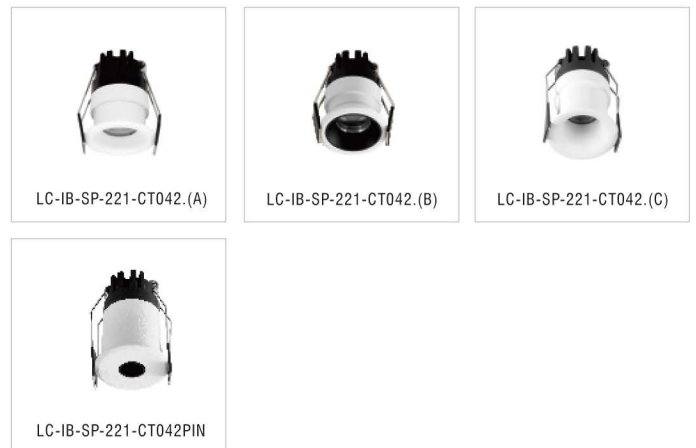
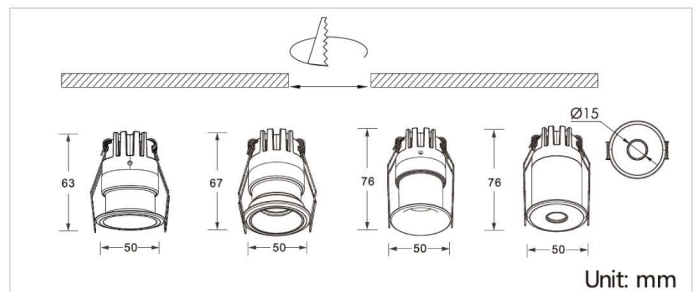

Model	Watts	D×H(mm.)	Cutout (mm.)	Lumen	Beam Angle
LC-IB-SP-221-CT042.(A)	3-7W	Ø50×H63	Ø42	70-90	15° 24° 38° 50°
LC-IB-SP-221-CT042.(B)	3-7W	Ø50×H67	Ø42	60-80	15° 24° 38° 50°
LC-IB-SP-221-CT042.(C)	3-7W	Ø50×H76	Ø42	60-80	15° 24° 38° 50°
LC-IB-SP-221-CT042PIN	3-7W	Ø50×H76	Ø42	40-50	24° 36°

ORDERING INFORMATION

Example : LC-IB-SP-221-CT042-3-7W-30-ND

Model	Watts	CCT	Beam	Dimming
LC-IB-SP-221-XXXX	XXXX	XX	XX	XX
LC-IB-SP-221-CT042	3-7W	27 2700K	15°	ND Non Dim
LC-IB-SP-221-CT042-PIN	3-7W	30 3000K	24°	TD Triac Dim
		35 3500K	36°	VD 0/1-10V Dim
		40 4000K		DA DALI Dim
		50 5000K		
		57 5700K		
		65 6500K		

LC-IB-DL-225

RECESSED DOWNLIGHT



ADJUSTABLE/FIXED



- ▶ SMD2835 LED 
- ▶ Beam Angle  100°
- ▶ PC diffuser / Prismatic diffuser 
- ▶ CCT version is optional 
- ▶ IP20; IP54 on the visible part of the product once installed 

ORDERING INFORMATION

Example : LC-IB-DL-225-CT200-42W-30-ND

Model	Watts	CCT	Dimming
LC-IB-DL-225-XXXXX	XXX	XX	XX
LC-IB-DL-225-CT090	15W	27 2700K	ND Non Dim
LC-IB-DL-225-CT115	20W	30 3000K	TD Triac Dim
LC-IB-DL-225-CT140	25W	35 3500K	VD 0/1-10V Dim
LC-IB-DL-225-CT170	35W	40 4000K	DA DALI Dim
LC-IB-SP-101-CT095	42W	57 5700K	
LC-IB-DL-225-CT200		65 6500K	

SPECIFICATION

Wattage	: 15W 20W 25W 35W 42W
CRI	: 80 90
CCT	: 2700K 3000K 3500K 4000K 5000K 5700K 6500K
Beam	: 100°
Lumen	: 1500 lm 2000 lm 2500 lm 3500 lm 4200 lm
Finish	: Matt white or black trim
Material	: Die-casting alu. trim and heatsink, PC.Diffuser
Driver	: Constant current remote LED driver included
Application	: Residential lighting, hotel and villas, bars, restaurants, etc.

DIMENSION (Unit mm.)

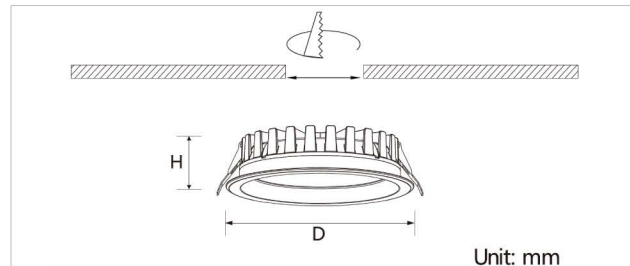

Unit: mm



Model	Watts	D×H(mm.)	Cutout (mm.)	Lumen
LC-IB-DL-225-CT090	15W	Ø109×H50	Ø90	100-120
LC-IB-DL-225-CT115	20W	Ø134×H50	Ø115	100-120
LC-IB-DL-225-CT140	25W	Ø160×H52	Ø140	100-120
LC-IB-DL-225-CT170	35W	Ø188×H52	Ø170	100-120
LC-IB-DL-225-CT200	42W	Ø227×H52	Ø200	100-120
LC-IB-DL-225-CT090-CCT	15W	Ø109×H50	Ø90	100-120
LC-IB-DL-225-CT115-CCT	20W	Ø134×H50	Ø115	100-120
LC-IB-DL-225-CT140-CCT	25W	Ø160×H52	Ø140	100-120
LC-IB-DL-225-CT170-CCT	35W	Ø188×H52	Ø170	100-120
LC-IB-DL-225-CT200-CCT	42W	Ø227×H52	Ø200	100-120







LC-IB-DL-226

RECESSED DOWNLIGHT



ADJUSTABLE/FIXED



- ▶ SMD2835 LED 
- ▶ CCT version is optional 
- ▶ Beam Angle  85°
- ▶ Pure aluminium optical reflector- Mirror/Silver/White/Black 
- ▶ PC diffuser / Prismatic diffuser 
- ▶ IP20; IP54 on the visible part of the product once installed 

Accessories

Reflector



SPECIFICATION

- Wattage** : 15W | 20W | 25W | 35W | 42W
- CRI** : 80 | 90
- CCT** : 2700K | 3000K | 3500K | 4000K
5000K | 5700K | 6500K
- Beam** : 85°
- Lumen** : 1500 lm | 2000 lm | 2500 lm | 3500 lm | 4200 lm
- Finish** : Matt white or black trim
- Material** : Die-casting alu. trim and heatsink, PC.Diffuser
- Driver** : Constant current remote LED driver included
- Application** : Residential lighting, hotel and villas, bars, restaurants, etc.

DIMENSION (Unit mm.)

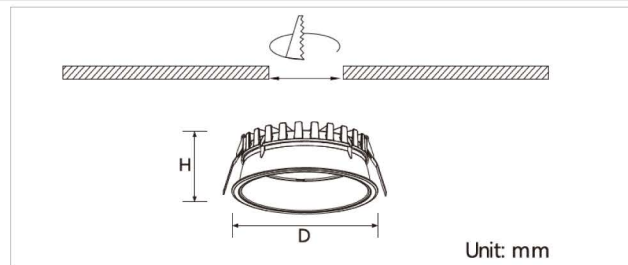

Unit: mm



Model	Watts	D×H(mm.)	Cutout (mm.)	Lumen
LC-IB-DL-226-CT090	15W	Ø104×H69	Ø90-95	100-110
LC-IB-DL-226-CT115	20W	Ø129×H69	Ø115-120	100-110
LC-IB-DL-226-CT140	25W	Ø155×H74	Ø140-145	100-120
LC-IB-DL-226-CT175	35W	Ø190×H74	Ø170-178	100-120
LC-IB-DL-226-CT200	42W	Ø220×H84	Ø200-208	100-120
LC-IB-DL-226-CT090-CCT	15W	Ø104×H69	Ø90-95	100-110
LC-IB-DL-226-CT115-CCT	20W	Ø129×H69	Ø115-120	100-110
LC-IB-DL-226-CT140-CCT	25W	Ø155×H74	Ø140-145	100-120
LC-IB-DL-226-CT175-CCT	35W	Ø190×H74	Ø170-178	100-120
LC-IB-DL-226-CT200-CCT	42W	Ø220×H84	Ø200-208	100-120

ORDERING INFORMATION

Example : LC-IB-DL-226-CT200-42W-30-ND

Model	Watts	CCT	Dimming
LC-IB-DL-226-XXXXX	XXX	XX	XX
LC-IB-DL-226-CT090	15W	27 2700K	ND Non Dim
LC-IB-DL-226-CT115	20W	30 3000K	TD Triac Dim
LC-IB-DL-226-CT140	25W	35 3500K	VD 0/1-10V Dim
LC-IB-DL-226-CT175	35W	40 4000K	DA DALI Dim
LC-IB-DL-226-CT200	42W	50 5000K	
		57 5700K	
		65 6500K	

LC-IB-DL-238

SURFACE DOWNLIGHT



ADJUSTABLE/FIXED

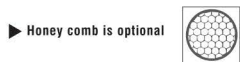

SPECIFICATION

Wattage	: 18W 30W 50W
CRI	: 80 90
CCT	: 2700K 3000K 3500K 4000K 5000K 5700K 6500K
Beam	: 60°
Lumen	: 1800 lm 3000 lm 5000 lm
Finish	: Matt white or black trim
Material	: Die-casting alu. trim and heatsink, Alu ref.
Driver	: Constant current remote LED driver included
Application	: Residential lighting, hotel and villas, bars, restaurants, etc.

DIMENSION (Unit mm.)

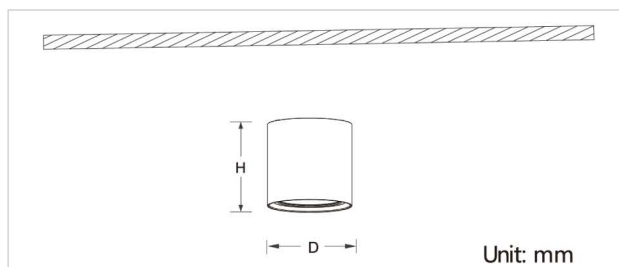

Model	Watts	D×H(mm.)	Cutout (mm.)	Lumen(lm/w)
LC-IB-DL-238-D090	15W	Ø90×H99	I	100-110
LC-IB-DL-238-D120	30W	Ø120×H118	I	100-120
LC-IB-DL-238-D168	50W	Ø168×H120	I	100-120

ORDERING INFORMATION

Example : LC-IB-DL-238-D090-15W-55-20D-ND

Model	Watts	CCT	Beam	Dimming
LC-IB-DL-238-XXXX	XXX	XX	XX	XX
LC-IB-DL-238-D090	15W	27 2700K	60°	ND Non Dim
LC-IB-DL-238-D120	30W	30 3000K		TD Triac Dim
LC-IB-DL-238-D168	50W	35 3500K		VD 0/1-10V Dim
		40 4000K		DA DALI Dim
		50 5000K		
		57 5700K		
		65 6500K		

LC-IB-DL-252

RECESSED DOWNLIGHT

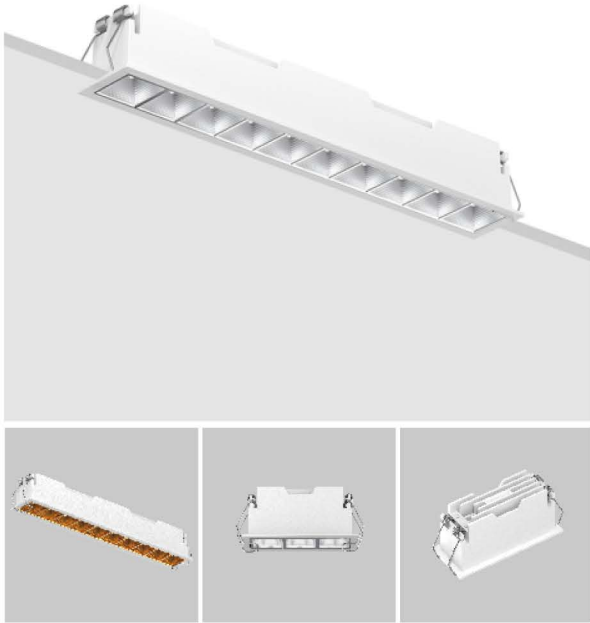

ADJUSTABLE/FIXED



- ▶ SMD5050
- ▶ Beam Angle
50° 80°
- ▶ Finish
- ▶ Mirror / Golden / Matt silver / Matt black optional

 Mirror Golden Matt silver Matt black

SPECIFICATION

- Wattage** : 6W | 9W | 15W | 30W
- CRI** : 80 | 90
- CCT** : 2700K | 3000K | 3500K | 4000K
5000K | 5700K | 6500K
- Beam** : 50° | 80°
- Lumen** : 600 lm | 900 lm | 1500 lm | 3000 lm
- Finish** : white / black
- Material** : Aluminum body and heatsink PC lens
- Driver** : Constant current remote LED driver included
- Application** : Residential lighting, hotel and villas, bars, restaurants, etc.

DIMENSION (Unit mm.)

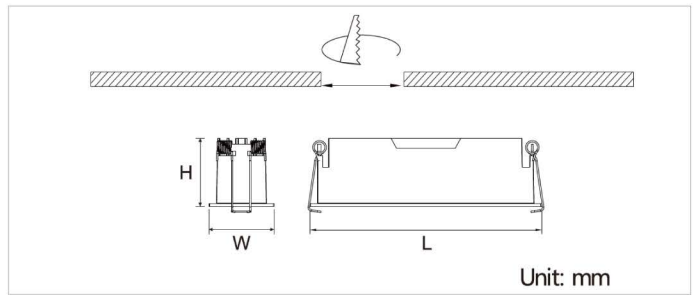

Model	Watts	L×W×H(mm.)	Cutout (mm.)
LC-IB-DL-252-CT068	6W	L73×W43×H47	L65×W35
LC-IB-DL-252-CT090	9W	L103×W43×H47	L95×W35
LC-IB-DL-252-CT140	15W	L153×W43×H42	L145×W35
LC-IB-DL-252-CT276	30W	L293×W43×H42	L285×W35

ORDERING INFORMATION

Example :LC-IB-DL-252-CT068-6W-30-ND

Model	Watts	CCT	Dimming
LC-IB-DL-252-XXXXX	XX	XX	XX
LC-IB-DL-252-CT068	6W	27 2700K	ND Non Dim
LC-IB-DL-252-CT090	9W	30 3000K	TD Triac Dim
LC-IB-DL-252-CT140	15W	35 3500K	VD 0/1-10V Dim
LC-IB-DL-252-CT276	30W	40 4000K	DA DALI Dim
		50 5000K	
		57 5700K	
		65 6500K	

LC-IB-DL-275

SURFACE DOWNLIGHT

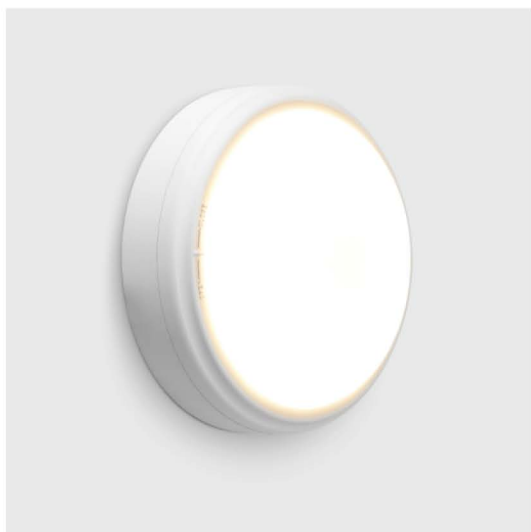

SPECIFICATION

Wattage	: 30W
CRI	: 80 90
CCT	: 2700K 3000K 3500K 4000K 5000K 5700K 6500K
Beam	: 160°
Lumen	: 3000 lm
Finish	: Matt white or black trim
Material	: Aluminum body and PC diffuser
Driver	: Constant current remote LED driver included
Application	: Residential lighting, hotel and villas, bars, restaurants, etc.

DIMENSION (Unit mm.)

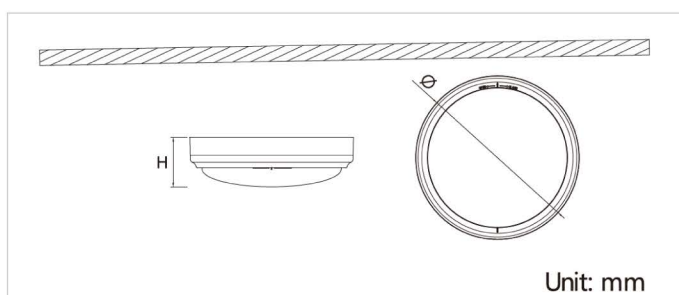

Model	Watts	D×H(mm.)	Cutout (mm.)	Lumen
LC-IB-DL-275	30W	Ø285×H86	/	100-120

ADJUSTABLE/FIXED



- ▶ SMD2835
- ▶ Beam Angle 160°
- ▶ IP65 with safety glass
- ▶ Finish
- ▶ Fixed

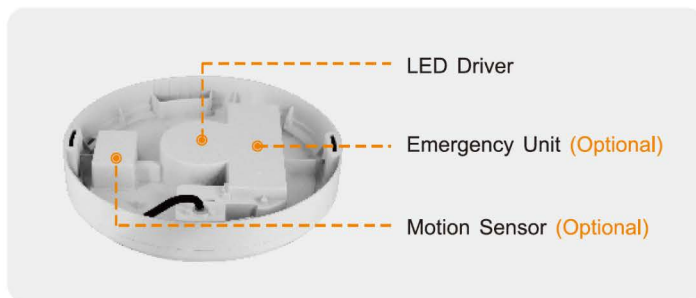

ORDERING INFORMATION

Example : LC-IB-DL-275-30W-100-120D-ND

Model	CCT	Beam	Dimming
LC-IB-DL-275	XX	160°	XX
LC-IB-DL-275	27 2700K 30 3000K 35 3500K 40 4000K 50 5000K 57 5700K 65 6500K	160°	ND Non Dim TD Triac Dim VD 0/1-10V Dim DA DALI Dim

LC-IB-TC-603

TRACK LIGHT



SPECIFICATION



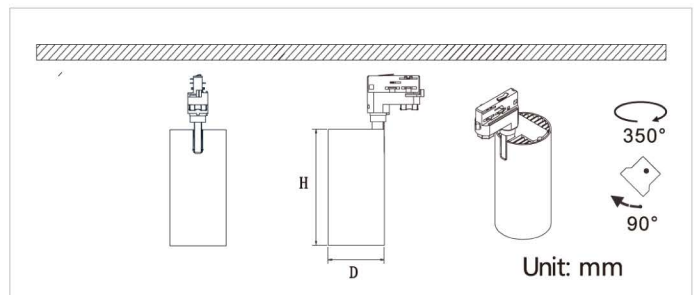

Wattage	: 12W 20W 36W
CRI	: 80 90
CCT	: 2700K 3000K 3500K 4000K 5000K 5700K 6500K
Beam	: 15° 24° 38° 60°
Finish	: Matt white or black trim
Material	: Die-casting alu. trim and heatsink
Driver	: Constant current remote LED driver included
Application	: Shop

DIMENSION (Unit mm.)

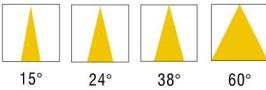

ADJUSTABLE/FIXED



- ▶ COB LED 
- ▶ Beam Angle 
- ▶ Glare cut-pff 40° 
- ▶ Honey comb is optional 
- ▶ UGR<17 
- ▶ Finish 

Model	Watts	D×H(mm.)	Track Type	Lumen(lm/w)
LC-IB-TC-603-D060	12W	Ø60×H130	2 3 4 6-line track	80-100
LC-IB-TC-603-D070	20W	Ø70×H160	2 3 4 6-line track	80-100
LC-IB-TC-603-D090	36W	Ø90×H185	2 3 4 6-line track	90-100

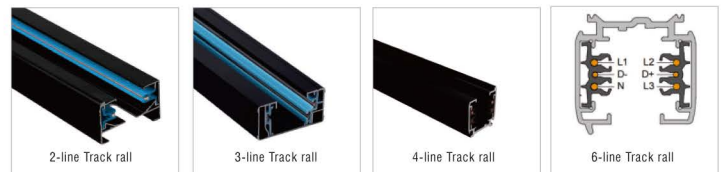

ORDERING INFORMATION

Example : LC-IB-TC-603-D060-12W-30-15D-ND

Model	Watts	CCT	Beam	Dimming
LC-IB-TC-603-XXXX	XXX	XX	XX	XX
LC-IB-TC-603-D060	12W	27 2700K	15°	ND Non Dim
LC-IB-TC-603-D070	20W	30 3000K	24°	TD Triac Dim
LC-IB-TC-603-D090	36W	35 3500K	38°	VD 0/1-10V Dim
		40 4000K	60°	DA DALI Dim
		50 5000K		
		57 5700K		
		65 6500K		

LC-IB-MTS

MAGNETIC TRACK LIGHT



SPECIFICATION

Wattage	: 10W 15W 20W
CRI	: 80 90
CCT	: 3000K 4000K 5700K
Beam	: 24° 36°
Lumen	: 1000 lm 1500 lm 2000 lm
Finish	: Matt white or black trim
Material	: Body and hest-sink in Die-casting aluminium
Driver	: Boke on/off & DALI
Application	: Residential lighting, hotel and villas, bars, restaurants, etc.

DIMENSION (Unit mm.)

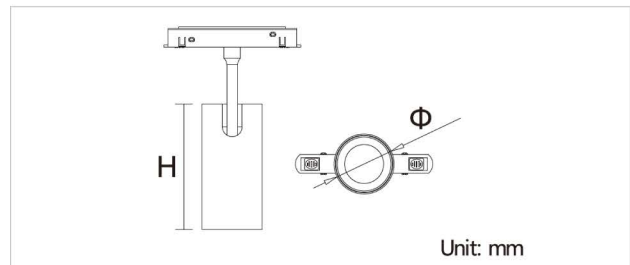

ADJUSTABLE/FIXED



Model	Watts	Ø×H(mm.)	Cutout (mm.)
LC-IB-MTS45	10W	Ø45×H100	I
LC-IB-MTS55	15W	Ø55×H115	I
LC-IB-MTS65	20W	Ø65×H135	I

Accessories



MST-S2621 M

MPT-2752

MFT-P6547

MFT-W6547

ORDERING INFORMATION

Example : LC-IB-MTS45-10W-30-ND

Model	Watts	CCT	Dimming
LC-IB-MTXXX	XXX	XX	XX
LC-IB-MTS45	10W	27 2700K	ND Non Dim
LC-IB-MTS55	15W	30 3000K	TD Triac Dim
LC-IB-MTS65	20W	35 3500K	VD 0/1-10V Dim
		40 4000K	DA DALI Dim
		50 5000K	
		57 5700K	
		65 6500K	

LC-IB-MTP

MAGNETIC TRACK LIGHT



ADJUSTABLE/FIXED



SPECIFICATION

Wattage	: 6W 10W
CRI	: 80 90
CCT	: 3000K 4000K 5700K
Beam	: 24° 36°
Lumen	: 480 lm 800 lm
Finish	: Matt silver or black trim / White
Material	: Body and hest-sink in Die-casting aluminium
Driver	: Boke on/off & DALI
Application	: Residential lighting,hotel and villas,bars,restaurants,etc.

DIMENSION (Unit mm.)

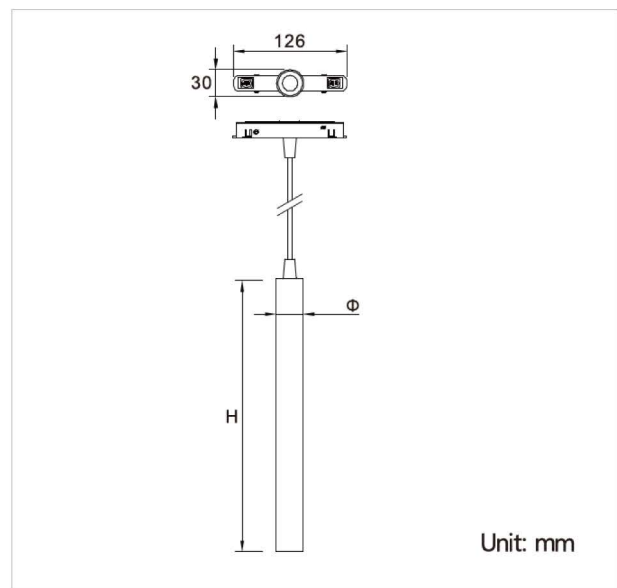

Model	Watts	Ø×H(mm.)	Cutout (mm.)
LC-IB-MTP30	6W	Ø30×H300	I
LC-IB-MTP40	10W	Ø40×H300	I

Accessories



ORDERING INFORMATION

Example : LC-IB-MTP30-6W-30-ND

Model	Watts	CCT	Dimming
LC-IB-MTPXX	XX	XX	XX
LC-IB-MTP30	6W	27 2700K	ND Non Dim
LC-IB-MTP40	10W	30 3000K	TD Triac Dim
		35 3500K	VD 0/1-10V Dim
		40 4000K	DA DALI Dim
		50 5000K	
		57 5700K	
		65 6500K	

LC-IB-MTL

MAGNETIC TRACK LIGHT

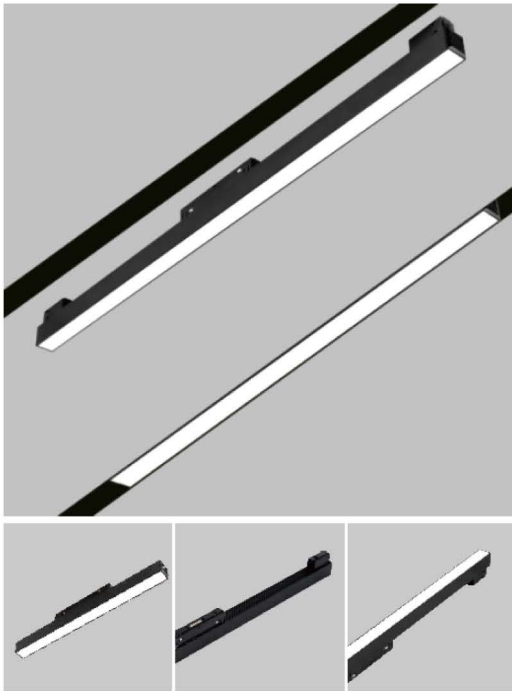

SPECIFICATION

Wattage	: 10W 20W
CRI	: 80 90
CCT	: 3000K 4000K 5700K
Beam	: 100°
Lumen	: 700 lm 1400 lm
Finish	: black trim
Material	: Body and hest-sink in aluminium
Driver	: Built-in
Application	: Residential lighting, hotel and villas, bars, restaurants, etc.

DIMENSION (Unit mm.)

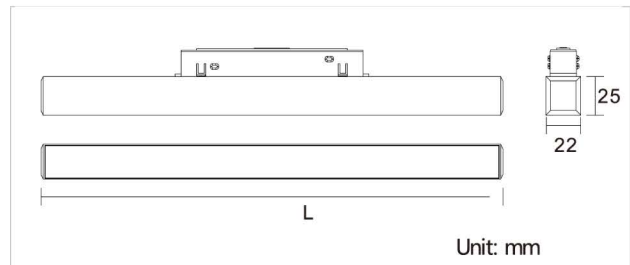

ADJUSTABLE/FIXED



Model	Watts	L×W×H(mm.)	Cutout (mm.)
LC-IB-MT-L300-W22	10W	L300 x W22×H25	I
LC-IB-MT-L600-W22	20W	L600 x W22×H25	I

Accessories



ORDERING INFORMATION

Example : LC-IB-MT-L300-W22-10W-30-ND

Model	Watts	CCT	Dimming
LC-IB-MT-XXXX-XXX	XXX	XX	XX
LC-IB-MT-L300-W22	10W	27 2700K	ND Non Dim
LC-IB-MT-L600-W22	20W	30 3000K	TD Triac Dim
		35 3500K	VD 0/1-10V Dim
		40 4000K	DA DALI Dim
		50 5000K	
		57 5700K	
		65 6500K	

LC-IB-MTG

MAGNETIC TRACK LIGHT



ADJUSTABLE/FIXED



SPECIFICATION

Wattage	: 12W 18W
CRI	: 80 90
CCT	: 3000K 4000K 5700K
Beam	: 24° 36°
Lumen	: 1200 lm 1800 lm
Finish	: Matt black trim
Material	: Body and hest-sink in aluminium
Driver	: Built-in
Application	: Residential lighting, hotel and villas, bars, restaurants, etc.

DIMENSION (Unit mm.)

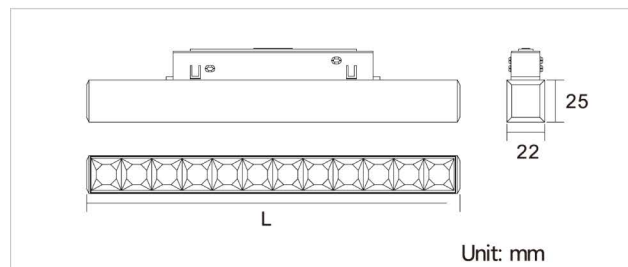

Model	Watts	L×W×H(mm.)	Cutout (mm.)
LC-IB-MTG-220-W22	12W	L220 x W22×H25	I
LC-IB-MTG-330-W22	18W	L330 x W22×H25	I

Accessories



ORDERING INFORMATION

Example : LC-IB-MTG-220-W22-12W-30-ND

Model	Watts	CCT	Dimming
LC-IB-MTG-XXX-XXX	XXX	XX	XX
LC-IB-MTG-220-W22	12W	27 2700K	ND Non Dim
LC-IB-MTG-330-W22	18W	30 3000K	TD Triac Dim
		35 3500K	VD 0/1-10V Dim
		40 4000K	DA DALI Dim
		50 5000K	
		57 5700K	
		65 6500K	

LC-IB-MTF

MAGNETIC TRACK LIGHT

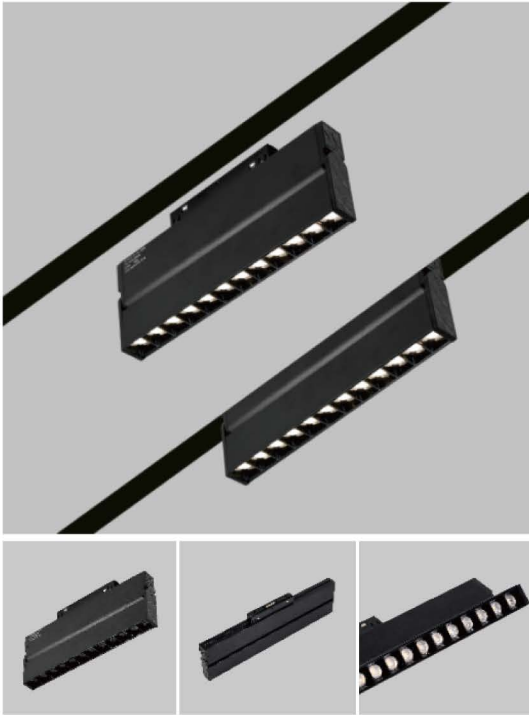

ADJUSTABLE/FIXED



SPECIFICATION

Wattage	: 12W
CRI	: 80 90
CCT	: 3000K 4000K 5700K
Beam	: 24° 36°
Lumen	: 1200 lm
Finish	: Matt Silver or black trim/White
Material	: Body and hest-sink in die-cast aluminium
Driver	: Boke on/off & DALI
Application	: Residential lighting,hotel and villas,bars,restaurants,etc.

DIMENSION (Unit mm.)

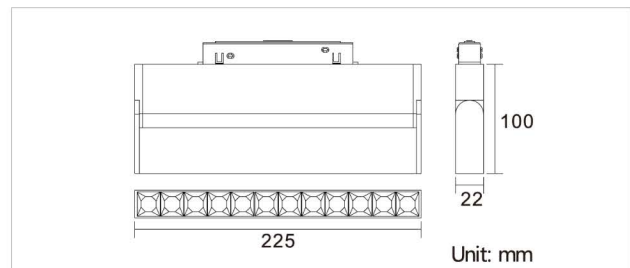

Model	Watts	L×W×H(mm.)	Cutout (mm.)
LC-IB-MTF-225-W22	12W	L225 x W22 x H100	I

Accessories



MST-S2621 M

MPT-2752

MFT-P6547

MFT-W6547

ORDERING INFORMATION

Example : LC-IB-MTF-225-W22-12W-30-ND

Model	Watts	CCT	Dimming
LC-IB-MTF-225-W22	12W	XX	XX
LC-IB-MTF-225-W22	12W	27 2700K	ND Non Dim
		30 3000K	TD Triac Dim
		35 3500K	VD 0/1-10V Dim
		40 4000K	DA DALI Dim
		50 5000K	
		57 5700K	
		65 6500K	

LC-IB-DL-260

SUSPENDED LINEAR LIGHT

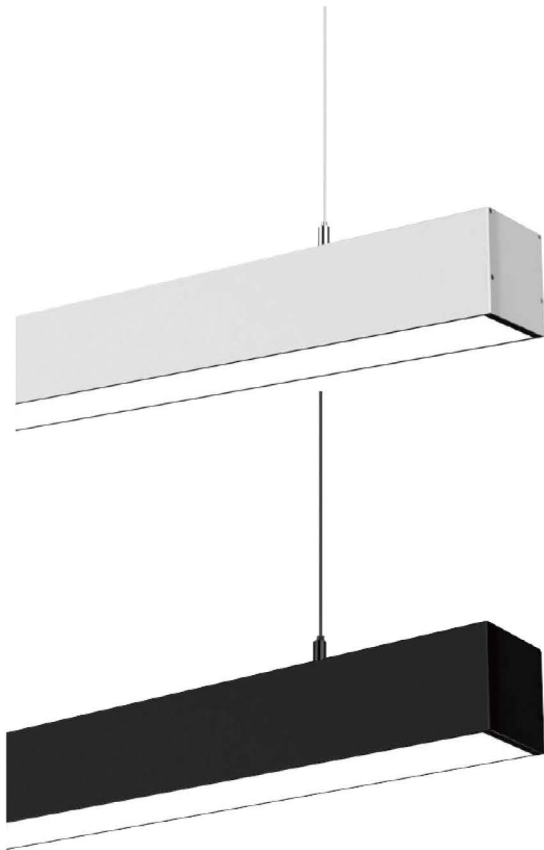

SPECIFICATION

Wattage	: 20W 36W 48W
CRI	: 80 90
CCT	: 2700K 3000K 3500K 4000K 5000K 5700K 6500K
Brand	: Osram Sanan
Type	: SMD
Beam	: 120°
Lumen	: 2000 lm 3600 lm 4800 lm
Finish	: Silver black
Material	: Die casting aluminium hest-sink
Driver	: Remote constant current LED driver
Input Voltage	: 220~240Vac 100-240Vac

DIMENSION (Unit mm.)

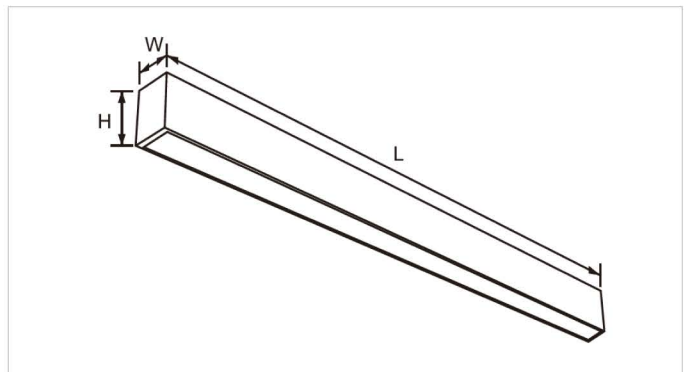

ADJUSTABLE/FIXED



Ra>80

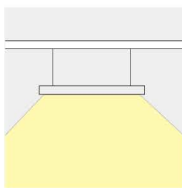

Model	Watts	L×W×H(mm.)	Cutout (mm.)
LC-IB-DL-260-D357	20W	L1204 x W35×H70	I
LC-IB-DL-260-D507	36W	L1204 x W50×H70	I
LC-IB-DL-260-D757	48W	L1204 x W75×H75	I

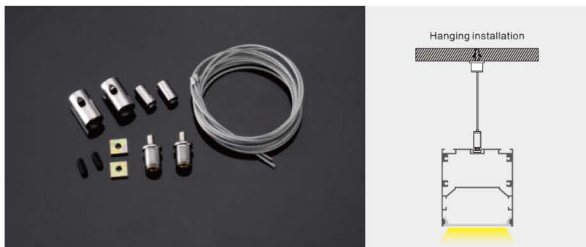

Hanging installation

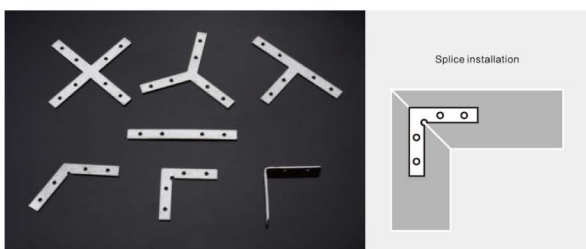

Splice installation

LC-IB-LL-3880

SUSPENDED LINEAR LIGHT



SPECIFICATION

Wattage	: 20W 40W 60W
CRI	: 80 90
CCT	: 2700K 3000K 3500K 4000K 5000K 5700K 6500K
Brand	: Osram Sanan
Type	: SMD
Beam	: 120°
Lumen	: 2000 lm 40000 lm 6000 lm
Finish	: White black
Material	: Die casting aluminium hest-sink
Driver	: Remote constant current LED driver
Input Voltage	: 220~240Vac 100-240Vac

DIMENSION (Unit mm.)

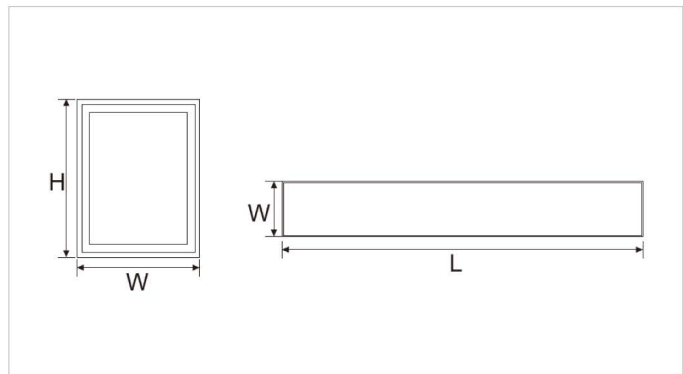

ADJUSTABLE/FIXED



Ra>80

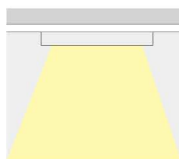

Model	Watts	L×W×H(mm.)	Cutout (mm.)
LC-IB-LL-3880	20W	L1204 x W38×H80	I
LC-IB-LL-5080	40W	L1204 x W50×H80	I
LC-IB-LL-6890	60W	L1204 x W68×H90	I

PHOTOMETRIC DATA

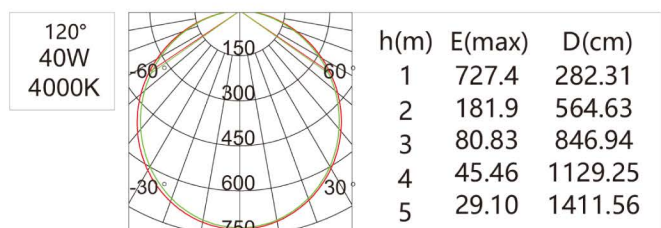
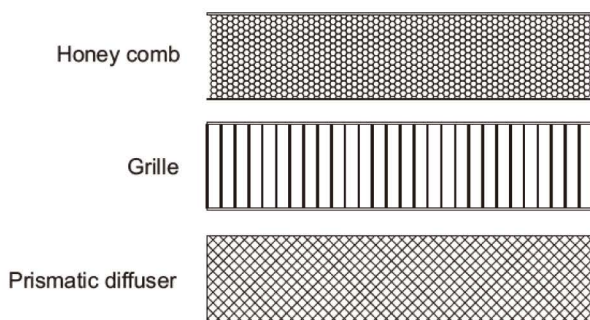

DL-2633F

DOWNLIGHT



SPECIFICATION

MODEL : DL-2633F
LAMP : LED 1xMR16 GU5.3
COLOR : SAND WHITE
MATERIAL : ALUMINUM + GLASS + STEEL
IP : 44

DIMENSION (Unit mm.)

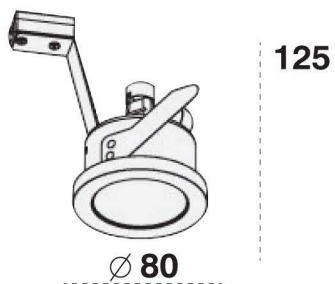

LAMP



LED MR16

ELECTRONIC TRANSFORMER



Philips Electronic
Transformer

HORN-MR16-BK

DOWNLIGHT



DIMENSION (Unit mm.)

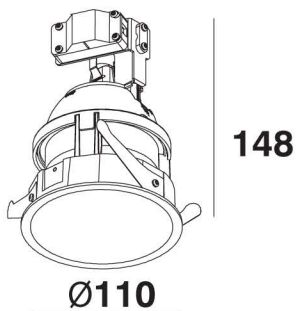

SPECIFICATION

MODEL	: HORN-MR16
LAMP	: LED 1xMR16 GU5.3
COLOR	: SAND BLACK
MATERIAL	: Alu Die-cast
IP	: 20

LAMP



LED MR16

ELECTRONIC TRANSFORMER



Philips Electronic
Transformer

HORN SQ-MR16

DOWNLIGHT



SPECIFICATION

Model : HORN SQ-MR16
Lamp : LED 1xMR16 GU5.3
Color : White
Material : Aluminium Extrusion
IP : 20

DIMENSION (Unit mm.)

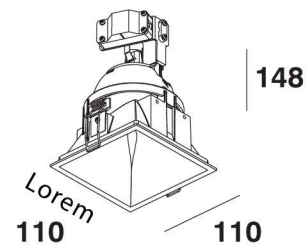

PHOTOMETRIC DATA

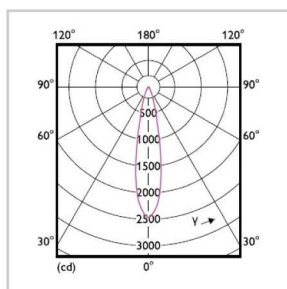

LAMP



LED MR16

LIGHT DISTRIBUTION

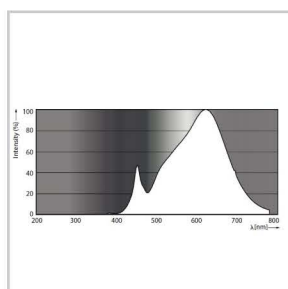

ELECTRONIC TRANSFORMER



Philips Electronic Transformer

LC-FASHION-MR16

DOWNLIGHT



SPECIFICATION

Model	:	LC-FASHION-MR16
Lamp	:	LED 1xMR16 GU5.3
Color	:	Sand White
Material	:	Aluminum Die-cast + Steel
IP	:	20

DIMENSION (Unit mm.)

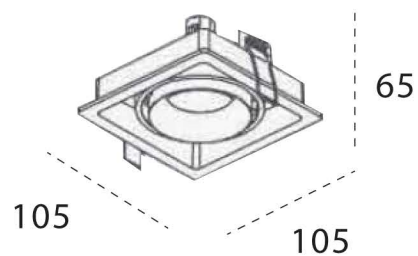

LAMP



LED MR16

ELECTRONIC TRANSFORMER



Philips Electronic
Transformer

LC-EASY2-MR16

DOWNLIGHT

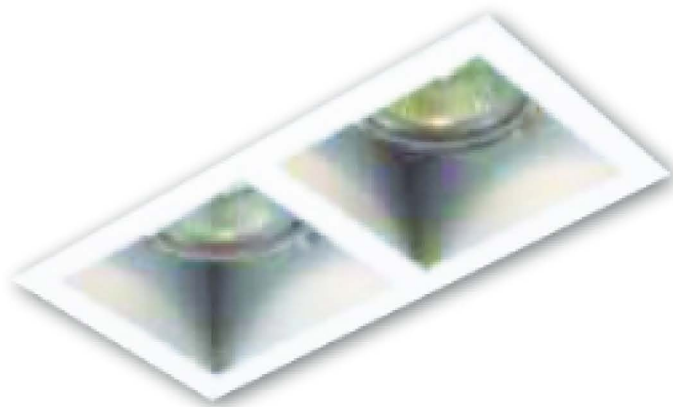

SPECIFICATION

Model	:	LC-EASY2-MR16
Lamp	:	LED 2xMR16 GU5.3
Color	:	Sand White
Material	:	Aluminum Die-cast + Steel
IP	:	20

DIMENSION (Unit mm.)

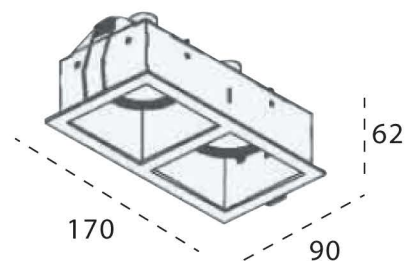

LAMP



LED MR16

ELECTRONIC TRANSFORMER



Philips Electronic
Transformer

LC-EASY-MR16

DOWNLIGHT



SPECIFICATION

MODEL : EASY-MR16
LAMP : LED 1xMR16 GU5.3
COLOR : SAND WHITE
MATERIAL : STEEL + ALUMINUM
IP : 20

DIMENSION (Unit mm.)

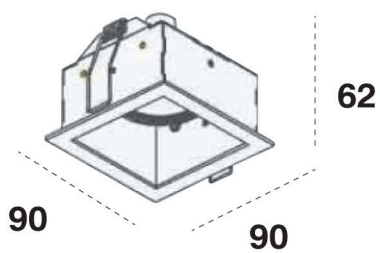

LAMP



LED MR16

ELECTRONIC TRANSFORMER



Philips Electronic
Transformer

WHITE MOON 5M

DOWNLIGHT



SPECIFICATION

Model	:	WHITE MOON 5M
MATERIAL	:	Aluminum Die-cast
WATT (MAX)	:	33W
CURRENT (MAX)	:	800mA
CHIP SIZE	:	02Q-1203 , 03Q-1206
ACCESSORIES	:	-
ADJUSTABLE	:	-
TILTABLE	:	-
ROTATABLE	:	-
BEAM ANGLE	:	95°
IP	:	40
Color	:	White

DIMENSION (Unit mm.)

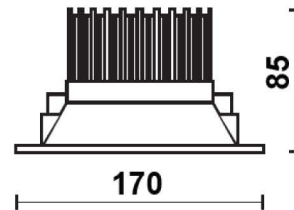

DRIVERS



OSRAM Optotronic OT FIT

DIPswitch programming device
Output ripple current (100 Hz) < 5%
Total harmonic distortion < 10%
Dim : No



VS EasyLine DIP switch

Selectable output current by DIP switch
Very low ripple current : < 1%
SELV
Dim : No



◆ LUMINOUS FLUX CHART

GEN9CITIZEN

LED COB Standard Type

LED Chip	Currents	CRI:90 Lumen(lm)				CRI:80 Lumen(lm)	Total Watts
		2700K	3000K	3500K	4000K	6500K	
02Q 1203	150	674	718	738	768	837	6W
	180	802	854	879	914	995	7W
	200	886	914	971	1010	1100	8W
	250	1002	1164	1164	1245	1356	11W
	300	1293	1378	1417	1474	1605	12W
	350	1488	1587	1631	1697	1848	15W
	400	1679	1790	1840	1914	2085	17W
	450	1865	1987	2043	2125	2315	19W
	500	2045	2180	2242	2332	2540	21W

LED Chip	Currents	CRI:90 Lumen(lm)				CRI:80 Lumen(lm)	Total Watts
		2700K	3000K	3500K	4000K	6500K	
03Q 1206	350	1577	1680	1719	1787	1954	15W
	400	1790	1907	1950	2028	2218	17W
	450	2000	2130	2179	2266	2478	19W
	500	2207	2351	2405	2500	2734	21W
	600	2613	2783	2847	2960	3237	25W
	650	2812	2995	3064	3186	3484	26W
	700	3008	3204	3278	3408	3727	28W
	800	3393	3614	3697	3844	4204	33W

- ◆ Base temperature : Tc 80°C
- ◆ Module lifetime : 50,000 hours
- ◆ Lumen output can be reduced by using less current output driver.
- ◆ Total watt consumption = Module Power + Driver Power, which will be varied.

LC-S1-VENUS 4S

DOWNLIGHT



beam angle



95°



LED CHIP



DRIVER



SPECIFICATION

LAMP TYPE	: LED Circular Downlight
HOUSING	: Aluminium die-casted + Polycarbonate Plastic
REFLECTOR	: Aluminium
DIFFUSER	: Opal acylic
ACCESSORIES	: -
WIRING	: Cable size AWG 20. under 105 C maximum Voltage 600V, TIS No.11-2531 °
Input Voltage	: 220 Vac

DIMENSION mm.

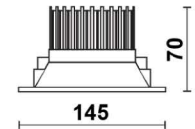
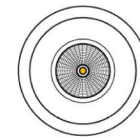

MODULE SPECIFICATIONS

Lumen Out (lm)

Lumen Output (lm)							TOTAL POWER	CRI
2700K	3000K	3500K	4000K	5000K	5700K	6500K	W	Ra
670	700	720	730	730	-	-	7	>80
870	920	940	960	960	-	-	9	
1070	1130	1150	1171	1170	-	-	11	
1250	1320	1340	1370	1370	-	-	13	
1420	1500	1530	1560	1560	-	-	15	
1880	1980	2020	-	-	-	-	21	

S1-STEVE x1 SQUARE

DOWNLIGHT

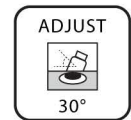

BEAM ANGLE



LED CHIP



DRIVER



MODULE SPECIFICATIONS

Lumen Out (lm)

Lumen Output (lm)							TOTAL POWER	CRI
2700K	3000K	3500K	4000K	5000K	5700K	6500K	W	Ra
670	700	720	730	730	-	-	7	>80
870	920	940	960	960	-	-	9	
1070	1120	1150	1170	1170	-	-	11	
1250	1320	1340	1370	1370	-	-	13	
1420	1500	1530	1560	1560	-	-	15	
-	2290	2330	2380	2380	-	-	21	
-	2670	2720	2772	2770	-	-	25	
-	3680	3750	3830	3830	-	-	33	
-	4610	4700	4800	4800	-	-	42	

DIMENSION mm.

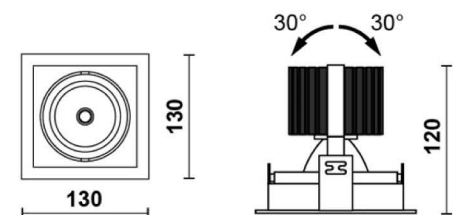

LAMP DETAILS

- TYPE : LED Square Downlight
- HOUSING : Cold rolled steel, Powder coated finished
- REFLECTOR : Aluminium
- DIFFUSER : -
- COLOR : White, Black
- WIRING : Cable size AWG 20. under 105°C max 600V, TIS No.11-2531

S1-STEVE x2 SQUARE

DOWNLIGHT



BEAM ANGLE

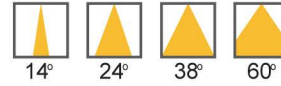

LED CHIP



DRIVER



DIMENSION mm.

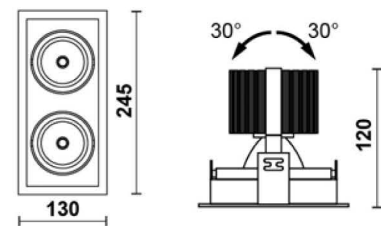

MODULE SPECIFICATIONS

Lumen Out (lm)

Lumen Output (lm)							TOTAL POWER	CRI
2700K	3000K	3500K	4000K	5000K	5700K	6500K	W	Ra
1340	1410	1430	1460	1460	-	-	14	>80
1750	1840	1880	1920	1920	-	-	18	
2140	2250	2300	2340	2340	-	-	22	
2500	2650	2690	2740	2740	-	-	26	
2840	2630	3050	3110	3110	-	-	30	
-	4570	4660	4760	4760	-	-	42	
-	5330	5440	5540	5550	-	-	50	
-	7360	7510	7650	7660	-	-	66	
-	9220	9410	9590	9590	-	-	84	

LAMP DETAILS

- TYPE : LED Square Downlight
- HOUSING : Cold rolled steel, Powder coated finished
- REFLECTOR : Aluminium
- DIFFUSER : -
- COLOR : White, Black
- WIRING : Cable size AWG 20. under 105°C max 600V, TIS No.11-2531

LC-S1-PLUTO-S

DOWNLIGHT



beam angle

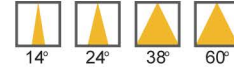

LED CHIP



SPECIFICATION

LAMP TYPE	: LED Circular Downlight
HOUSING	: Colod rolled steel, Powder coated finished
REFLECTOR	: Aluminium
DIFFUSER	: None / Clear / Opal diffuser (on request)
ACCESSORIES	: -
WIRING	: Cable size AWG 20. under 105 C maximum Voltage 600V, TIS No.11-2531
Input Voltage	: 220 Vac

DRIVER



DIMENSION mm.

MODULE SPECIFICATIONS

Lumen Out (lm)

Lumen Output (lm)							TOTAL POWER	CRI
2700K	3000K	3500K	4000K	5000K	5700K	6500K	W	Ra
670	700	720	730	730	-	-	7	>80
870	920	940	960	960	-	-	9	
1070	1120	1150	1170	1170	-	-	11	
1250	1320	1340	1370	1370	-	-	13	
1420	1500	1530	1560	1560	-	-	15	
-	2290	2330	2380	2380	-	-	21	
-	2670	2720	2772	2770	-	-	25	
-	3680	3750	3830	3830	-	-	33	
-	4610	4700	4800	4800	-	-	42	

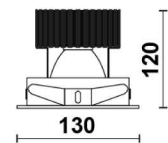

LC-S1-BARREL-S

DOWNLIGHT



beam angle



DRIVER



OSRAM Optotronic OT FIT

DIPswitch programming device
Output ripple current (100 Hz) < 5%
Total harmonic distortion < 10%
Dim : No

Life Time
50,000hrs.



VS EasyLine DIP switch

Selectable output current by DIP switch
Very low ripple current : < 1%
SELV
Dim : No

Life Time
50,000hrs.

DIMENSION mm.

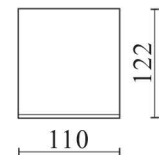
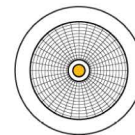

SPECIFICATION

LAMP TYPE	:	LED Circular Downlight
HOUSING	:	Aluminium die-casted + Plastic
BEAM ANGLE	:	24° , 45° , 60°
WATT (MAX)	:	12W
CURRENT (MAX)	:	300mA
Input Voltage	:	220 Vac

MODULE SPECIFICATIONS

Lumen Out (lm)

LED Chip	Currents	CRI:90 Lumen(lm)				CRI:80 Lumen(lm)	Total Watts
		2700K	3000K	3500K	4000K	6500K	
CLU	mA					W	
02Q 1203	150	674	718	738	768	837	6W
	180	802	854	879	914	995	7W
	200	886	914	971	1010	1100	8W
	250	1002	1164	1164	1245	1356	11W
	300	1293	1378	1417	1474	1605	12W

LC-C1-HI-F LPR

FLUORESCENT ACRYLIC DIFFUSER TYPE

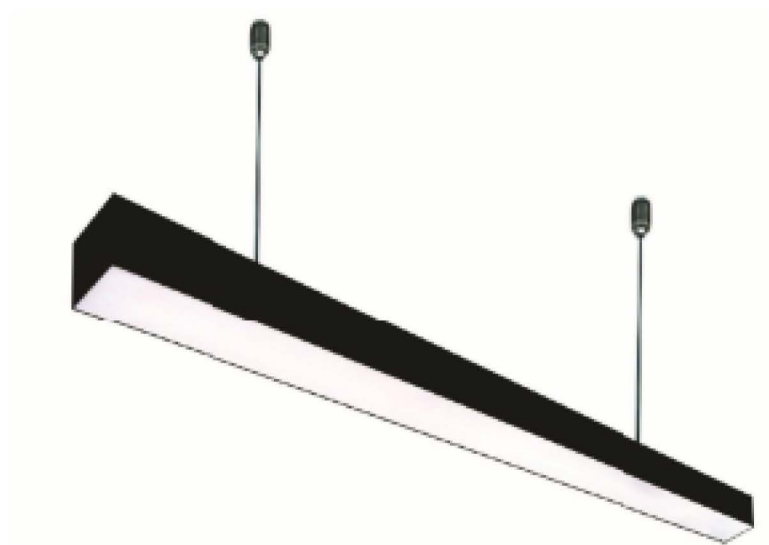

LAMP DETAILS

Model	: LC-C1-HI-F LPR
Light source	: 1 x LED TUBE T8
Material	: High grade cold-rolled steel sheet
Diffuser	: Opal acrylic / clear acrylic / stipple acrylic / prismatic acrylic
Color	: Black / White
IP	: 20
Input Voltage	: 200-240Vac~ 50Hz

LAMP



1 x LED Tube T8

DIMENSION mm.

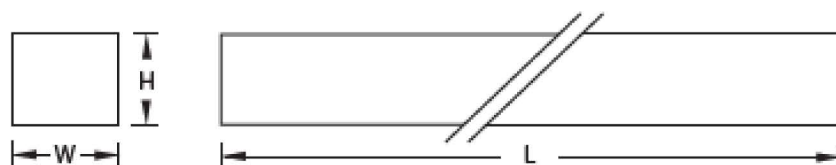

MODEL	LAMP	DIMENSION(mm.)			CUT OUT(mm.)	
		L	W	H	L	W
HI-FLPR-120A-8-S	1x18W T8	630	80	80	-	-
HI-FLPR-140A-8-S	1x36W T8	1225	80	80	-	-

LC-C1-HI-FMPK-LED

RECESS OFFICE LIGHT

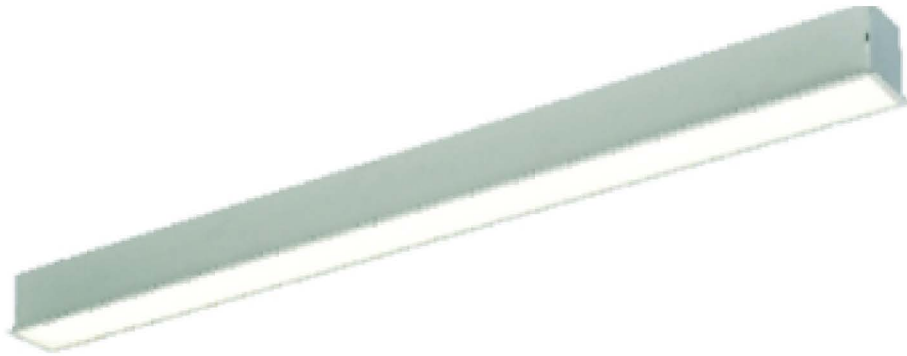

LAMP DETAILS

Model	: LC-C1-HI-FMPK-LED
Light source	: LED
Power	: 35W for PCB
Lumen	: 3500 lm
CCT	: 3000K / 4000K / 6500K
Beam Angle	: N/A
Material	: Aluminium
Diffuser	: PMMA
Color	: Black / White / Gray
IP	: 20
Input Voltage	: 200-240Vac~ 50Hz

DIMENSION mm.

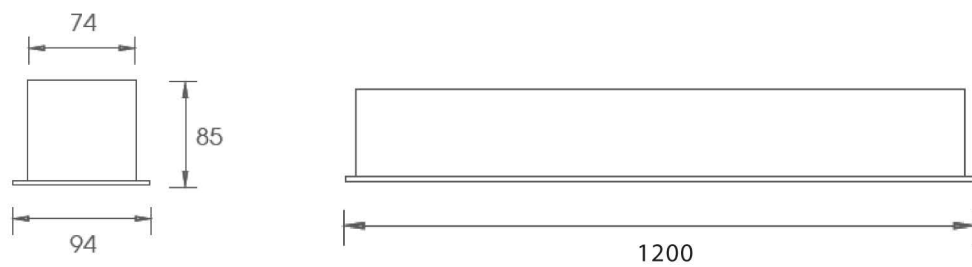

LC-S7-FLUO-2P

HANGING LAMP



SPECIFICATION

Model	:	LC-S7-FLUO-2P Suspension Luminaire
Lamp	:	2 × LED T8
Color	:	White
IP	:	20
Material	:	Aluminium
Diffuser	:	Acrylic
Dimension (mm.)	:	140x78x1250 mm.

DIMENSION (Unit mm.)

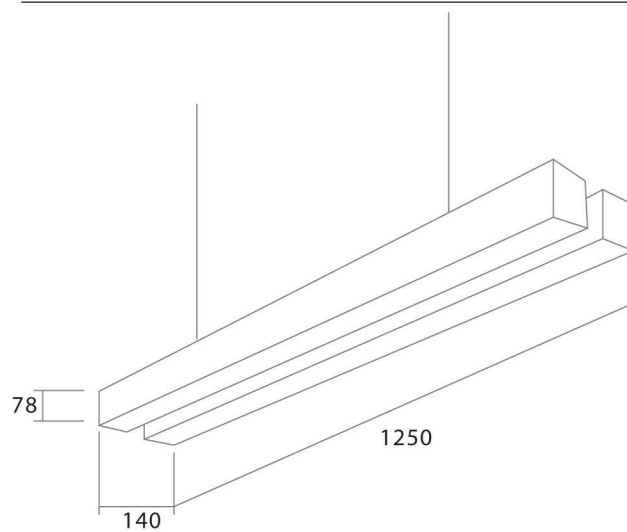

LAMP



2xPhilips Master LED TUBE
T8 14.7W 6500K Day light

ACCESSORY



1 x with cable set L: 1.5m.

LC-C1-HD4N-4 INCHES

DOWNLIGHT



SPECIFICATION

HOUSING	:	WHICH COLD-ROLLED STEEL SHEET FORMED BY HIGH QUALITY MACHINES
SURFACE TREATMENT	:	ION-PHOSPHATE AND ANTI-RUST FINISHED WITH UV RESISTANT POLYESTER POWDER COAT
REFLECTOR	:	HIGH GRADE ANODIZED ALUMINIUM (DIAMOND)
FRAME	:	STEEL WITH POLYESTER POWDER COAT
COLOR	:	WHITE, SILVER
PROTECTION CLASS	:	PROTECTION CLASS EQUIVALENT TO IP 20
INSTALLATION	:	RECESS T-BAR CEILING, RECESS CONCEAL
	:	CEILING
APPLICATION	:	BUILDING, HOSPITAL, DEPARTMENT STORE, HOTEL CONDOMINIUM, RESTAURANT, SHOWROOM, SHOP, RESIDENTIAL, ETC.

DIMENSION (Unit mm.)

(4 inches)

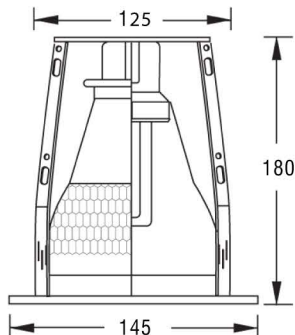

LAMP



E 27

LC-DL-1713A-EN- 6 INCHES

DOWNLIGHT



SPECIFICATION

HOUSING	:	COLD-ROLL STEEL SHEET, COATED WITH POLYESTER POWDER
SURFACE TREATMENT	:	ION-PHOSPHATE AND ANTI-RUST FINISHED WITH UV RESISTANT POLYESTER POWDER COAT
REFLECTOR	:	HIGH GRADE ANODIZED ALUMINIUM (DIAMOND)
FRAME	:	STEEL WITH POLYESTER POWDER COAT
COLOR	:	WHITE
PROTECTION CLASS	:	PROTECTION CLASS EQUIVALENT TO IP 20
INSTALLATION	:	RECESS T-BAR CEILING, RECESS CONCEAL
	:	CEILING
APPLICATION	:	BUILDING, HOSPITAL, DEPARTMENT STORE, HOTEL CONDOMINIUM, RESTAURANT, SHOWROOM, SHOP, RESIDENTIAL, ETC.

DIMENSION (Unit mm.)

(6 inches)

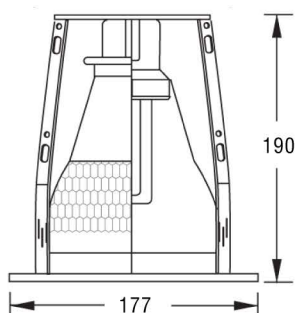

LAMP



E 27

Accessories

Reflector



ANODIZED
ALUMINIUM
(DIAMOND)

LC-C1-LUNA-140

DOWNLIGHT



SPECIFICATION

POWER	:	E27 MAX 8W
INPUT VOLTAGE	:	220-240VAC
LUMEN	:	N/A
COLOR TEMPERATURE	:	N/A
CRI	:	N/A
BEAM ANGLE	:	N/A
DIMENSION	:	D138xH140mm
CEILING CUT	:	D123mm
MATERIAL	:	Aluminium
COLOR AVAILABLE	:	White
LIGHT DISTRIBUTION	:	Direct
MOUNTING	:	Recessed
DRIVER	:	-
DIMMABLE	:	Non-Dimmable
IP RATING	:	IP20

DIMENSION (Unit mm.)

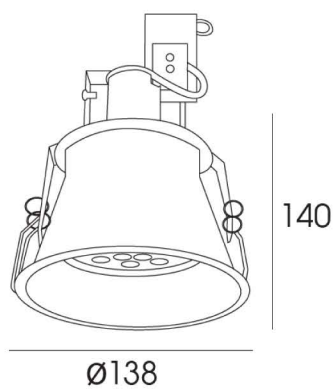

LAMP



E 27

LC-C1-LUNA SQUARE

DOWNLIGHT



SPECIFICATION

POWER	:	LED BULB E27
INPUT VOLTAGE	:	220-240Vac/50Hz
LUMEN	:	N/A
COLOR TEMPERATURE	:	N/A
CRI	:	N/A
BEAM ANGLE	:	N/A
DIMENSION	:	W110xL110xH150mm
CEILING CUT	:	W97xL97mm
MATERIAL	:	Steel
COLOR AVAILABLE	:	White
LIGHT DISTRIBUTION	:	Direct
MOUNTING	:	Recessed
DRIVER	:	-
DIMMABLE	:	Non-Dimmable
IP RATING	:	IP20

DIMENSION (Unit mm.)

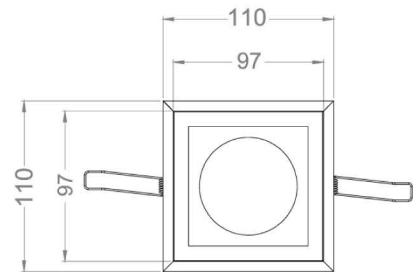
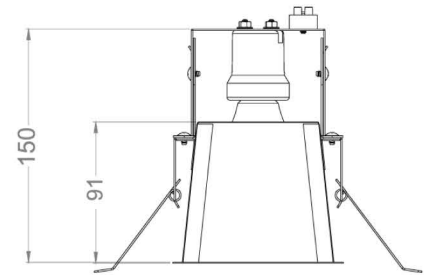

LC-S5-6W-552

DOWNLIGHT

SPECIFICATION

POWER	:	E27
INPUT VOLTAGE	:	220-240VAC
LUMEN	:	N/A
COLOR TEMPERATURE	:	N/A
CRI	:	N/A
BEAM ANGLE	:	N/A
DIMENSION (ØxH)	:	Ø14.8 x 17
CEILING CUT	:	Ø12
MATERIAL	:	Steel
COLOR AVAILABLE	:	White
LIGHT DISTRIBUTION	:	Direct
MOUNTING	:	Recessed
DRIVER	:	-
DIMMABLE	:	Non-Dimmable
IP RATING	:	IP20



DIMENSION (Unit mm.)

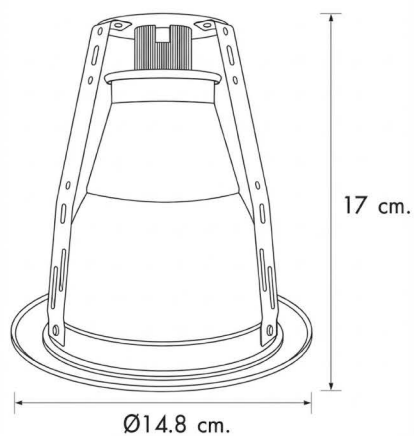

LAMP



E 27

LC-S5-6-BSW-552-2

DOWNLIGHT

SPECIFICATION

POWER	:	E27
INPUT VOLTAGE	:	220-240VAC
LUMEN	:	N/A
COLOR TEMPERATURE	:	N/A
CRI	:	N/A
BEAM ANGLE	:	N/A
DIMENSION (WxLxH)	:	13.5 x 13.5 x 17
CEILING CUT	:	Ø12
MATERIAL	:	Steel
COLOR AVAILABLE	:	White
LIGHT DISTRIBUTION	:	Direct
MOUNTING	:	Recessed
DRIVER	:	-
DIMMABLE	:	Non-Dimmable
IP RATING	:	IP20



DIMENSION (Unit mm.)

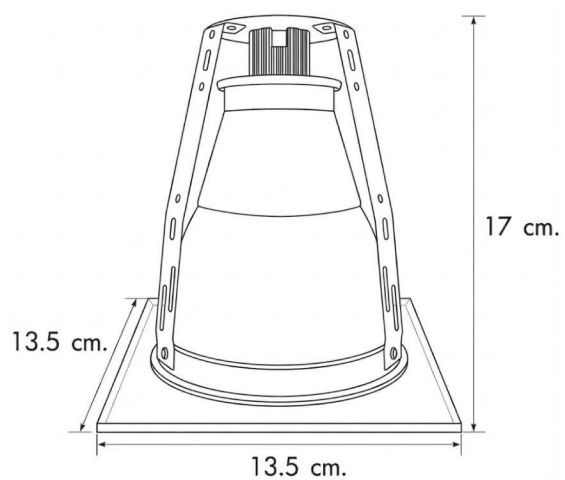

LAMP



E 27

LC-S5-ASW-552

DOWNLIGHT

SPECIFICATION

POWER	:	E27
INPUT VOLTAGE	:	220-240VAC
LUMEN	:	N/A
COLOR TEMPERATURE	:	N/A
CRI	:	N/A
BEAM ANGLE	:	N/A
DIMENSION (ØxH)	:	Ø14.8 x 18
CEILING CUT	:	Ø12
MATERIAL	:	Steel+Glass
COLOR AVAILABLE	:	White
LIGHT DISTRIBUTION	:	Direct
MOUNTING	:	Recessed
DRIVER	:	-
DIMMABLE	:	Non-Dimmable
IP RATING	:	IP20



DIMENSION (Unit mm.)

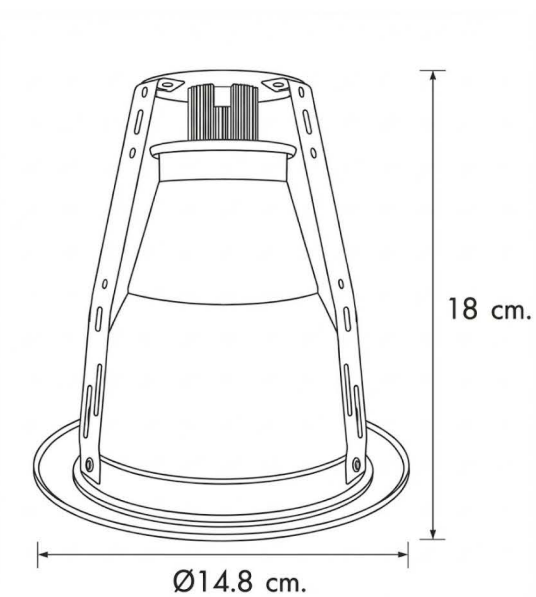

LAMP



E 27

CS401A

DOWNLIGHT



SPECIFICATION

MODEL	:	CS401A
LAMP	:	1xE27
COLOR	:	WHITE
MATERIAL	:	HIGH COLD-ROLLED STEEL SHEET
DIFFUSER	:	FROSTED GLASS DIFFUSER

LED REPLACEMENT



LED-BULB TC-TSE / E27

DIMENSION (Unit mm.)

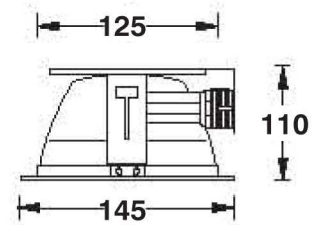

LC-C1-120D, 140D OPEN FRONTED TYPE

Surface LED Standard Batten



SPECIFICATION

HOUSING	:	HIGH GRADE COLD-ROLLED STEEL SHEET FORMED BY HIGH QUALITY MACHINES
SURFACE TREATMENT	:	ION-PHOSPHATE AND ANTI-RUST FINISHED WITH UV RESISTANT WHITE POLYESTER POWDER COAT
WIRES	:	THW, TIS.11-1988 STANDARD
LAMP HOLDER	:	SPRING LOCKED TYPE HIGH-HEAT RESISTANCE, TIS344-1987 STANDARD ROTOR LOCKED TYPE HIGH-HEAT RESISTANCE, TIS344-1987 STANDARD
STARTER HOLDER	:	ROTOR LOCKED TYPE HIGH-HEAT RESISTANCE, TIS344-1987 STANDARD
PROTECTION CLASS	:	PROTECTION CLASS EQUIVALENT TO IP 20 SURFACE MOUNT OR SUSPEND MOUNT
INSTALLATION APPLICATION	:	FACTORY, WAREHOUSE, SHOP, RESIDENTIAL, CAR PARK, ETC.

DIMENSION (Unit mm.)

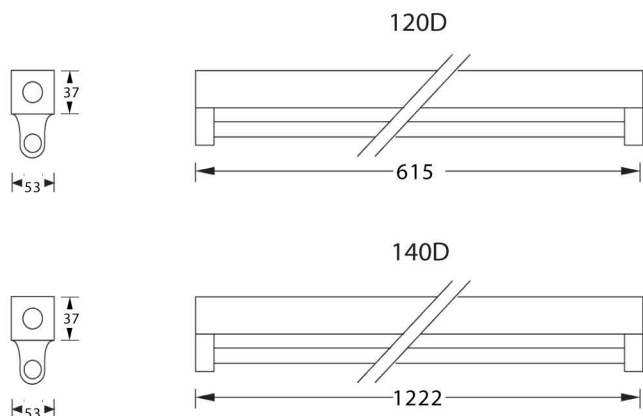

LAMP



T8 LED Tube

LC-C1-120, 140 U-SHAPE TYPE

U-Shape Acrylic Clear Diffuse



SPECIFICATION

HOUSING	:	HIGH GRADE COLD-ROLLED STEEL SHEET FORMED BY HIGH QUALITY MACHINES
SURFACE TREATMENT	:	ION-PHOSPHATE AND ANTI-RUST FINISHED WITH UV RESISTANT WHITE POLYESTER POWDER COAT
REFLECTOR	:	PARABOLIC HIGH PURITY ANODIZED ALUMINIUM 99.85% MIRROR FINISH, TOTAL REFLECTION 87%(DIN 5063-3) FORM GERMANY
(OPTIONAL)	:	PARABOLIC HIGH PURITY ANODIZED ALUMINIUM 99.99% MIRROR FINISH, TOTAL REFLECTION 95%(DIN 5063-3) FORM GERMANY
DIFFUSER	:	OPAL ACRYLIC (OP), CLEARACRYLIC (CL), STIPPLE ACRYLIC (ST), PRISMATIC ACRYLIC (PR)
WIRES	:	THW, TIS.11-1988 STANDARD
LAMP HOLDER	:	ROTOR LOCKED TYPE HIGH-HEAT RESISTANCE, TIS344-1987 STANDARD WATER AND DUSTPROOF LAMP HOLDER FROM GERMANY, IEC 60400/VDE 0615 PART3.
PROTECTION CLASS	:	PROTECTION CLASS EQUIVALENT TO IP 44
INSTALLATION	:	SURFACE MOUNT OR SUSPEND MOUNT
APPLICATION	:	OFFICE BUILDING, HOSPITAL, DEPARTMENT STORE UNIVERSITY, GOVERNMENTAL BUILDING, FACTORY SHOP, WAREHOUSE, RESIDENTIAL, TOILET, CANTEEN CLEAN ROOM, ETC.

LAMP



T8 LED Tube

DIMENSION (Unit mm.)

120D

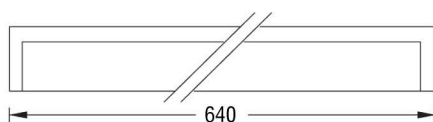
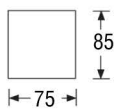

140D

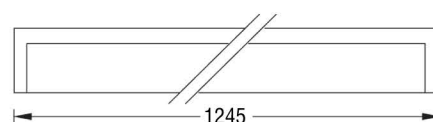
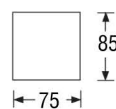

LC-L7430-6

DOWNLIGHT



SPECIFICATION

MODEL : L7430-6
LAMP : LED 6W 3000K
COLOR : WHITE
MATERIAL : DIE-CAST ALUMINIUM
IP : 20

DIMENSION (Unit mm.)

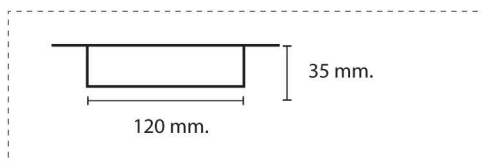

LED REPLACEMENT



LED CHIP

LC-WT-CL48-8

DOWNLIGHT

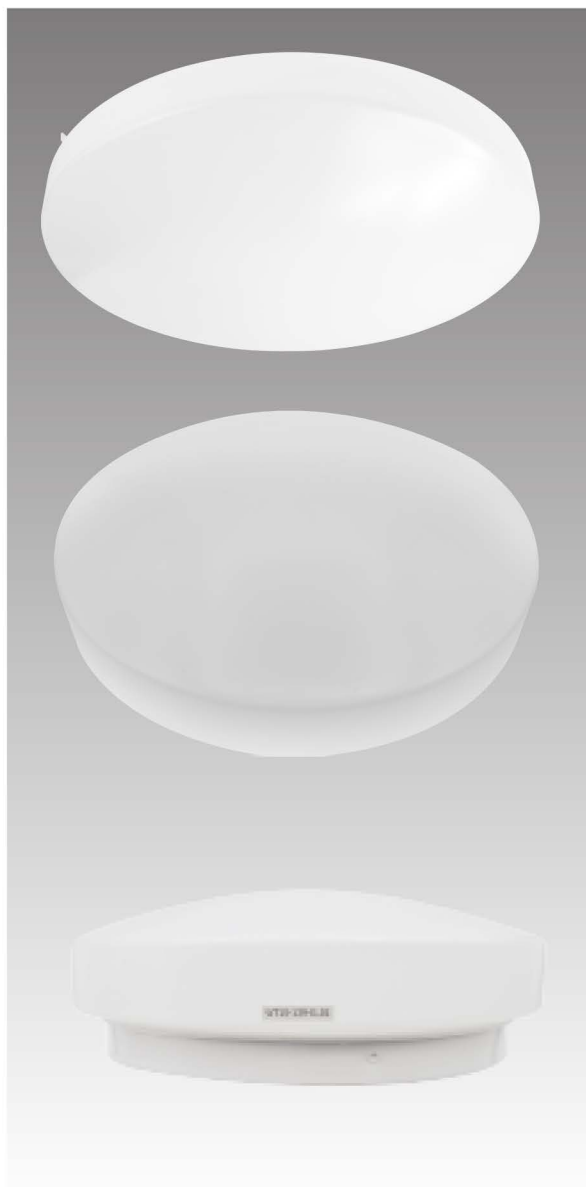

SPECIFICATION

MODEL : WT-CL48-8
LAMP : 1xE27
COLOR : WHITE, BLACK
MATERIAL : PAINTED METAL PLATE
DIFFUSER : OPAL POLYCARBONATE
INSTALLATION : METAL PLATE WITH WITH CLIP LOCK

DIMENSION (Unit mm.)

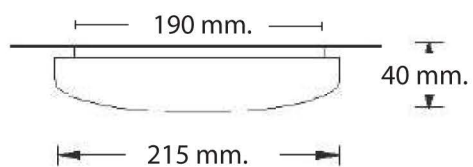

LED REPLACEMENT



TC-TSE / E27



LED

LC-Z1-ZB10-24W Slim Ceiling LED

WALL LAMP



SPECIFICATION

POWER	:	24W
LIGHT SOURCE	:	SMD
LUMEN	:	1920 lm
LUMEN/WATT	:	80 lm/W
CCT	:	6500K
MATERIAL	:	Iron,PVC
COLOR	:	White
DRIVER	:	Build-in-Driver
IP	:	IP20
INPUT VOLTAGE	:	220-240VAC
DIMENSION (mm.)	:	Ø380 x H45

DIMENSION (Unit mm.)

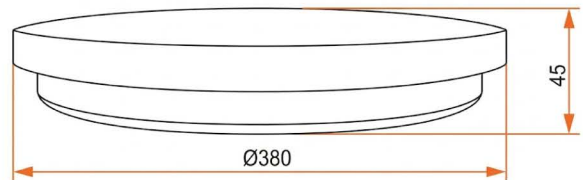

LC-ZG NIKITA

WALL LAMP

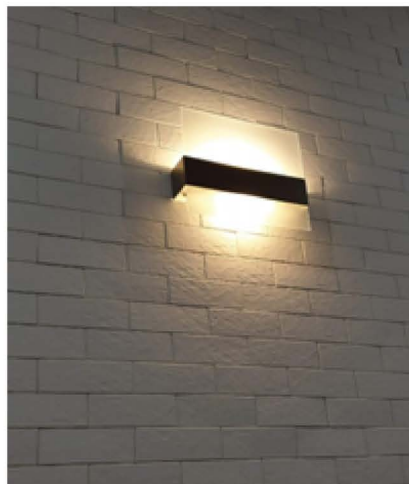

SPECIFICATION

Model	:	LC-ZG NIKITA
Light source	:	2xLED Stick T14 E27
Power	:	2x12W
Lumen	:	2x1425 lm
Lumen/Watt	:	118lm/W
CCT	:	4000K
CRI	:	>80
Beam Angle	:	120°
Material	:	Steel and Glass
Color	:	Silver
Optical cover	:	Glass
IP	:	20
Power Voltage	:	200-240V~ 50Hz
Dimension (WxLxH)	:	80x350xH290mm.

DIMENSION (Unit of mm.)

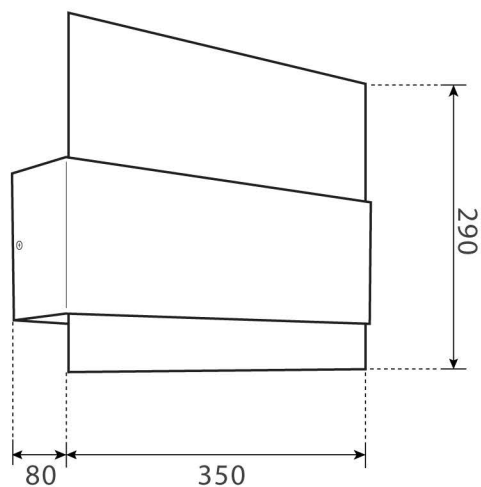

LED REPLACEMENT



LED Stick T14 E27

LC-W1-SQ140-BK

WALL LAMP

SPECIFICATION

POWER	:	2 x 3W
LIGHT SOURCE	:	LED BULB
LUMEN	:	2 x 300 lm
LUMEN/WATT	:	100 lm/W
CCT	:	3000K
MATERIAL	:	Aluminium,Glass
COLOR	:	Black
DRIVER	:	-
IP	:	IP54
INPUT VOLTAGE	:	220-240VAC
DIMENSION (mm.)	:	W150 x Ø90 x H300



DIMENSION (Unit mm.)



LAMP



2 x 3W

LC-S1-STUDIO-S

DOWNLIGHT



beam angle



DRIVER



OSRAM Optotronic OT FIT

DIPswitch programming device
Output ripple current (100 Hz) < 5%
Total harmonic distortion < 10%
Dim: No



VS EasyLine DIP switch

Selectable output current by DIP switch
Very low ripple current: < 1%
SELV
Dim: No

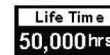

LAMP DETAILS

Model	: LC-S1-STUDIO-S
Light source	: LED
Power	: 6W / 7W / 8W / 11W / 12W / 15W / 17W / 19W / 21W
CCT	: 2700K / 3000K / 3500K / 4000K / 6500K
Beam Angle	: 12° / 24° / 38°
Material	: Aluminium die-casted
Color	: Black / White
IP	: 20
Input Voltage	: 200-240Vac~ 50Hz

DIMENSION mm.

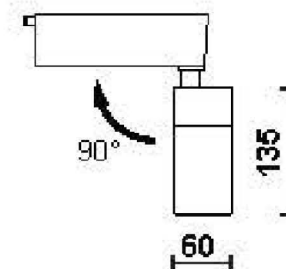

MODULE SPECIFICATIONS

Lumen Out (lm)

LED Chip	Currents	CRI:90 Lumen(lm)				CRI:80 Lumen(lm)	Total Watts
		2700K	3000K	3500K	4000K	6500K	
CLU	mA						W
02Q 1203	150	674	718	738	768	837	6W
	180	802	854	879	914	995	7W
	200	886	914	971	1010	1100	8W
	250	1002	1164	1164	1245	1356	11W
	300	1293	1378	1417	1474	1605	12W
	350	1488	1587	1631	1697	1848	15W
	400	1679	1790	1840	1914	2085	17W
	450	1865	1987	2043	2125	2315	19W
	500	2045	2180	2242	2332	2540	21W

LC-LED STRIP-4.8W

LED STRIP LIGHT



SPECIFICATION

Light source	:	3528 SMD LED
LED Quantity	:	30 pcs. LED/m.
Power	:	14.4W
Input Voltage	:	12V DC
Package	:	5m. / Reel
CRI	:	>90
Beam Angle	:	120°
CCT	:	3000K



DIMENSION (Unit mm.)

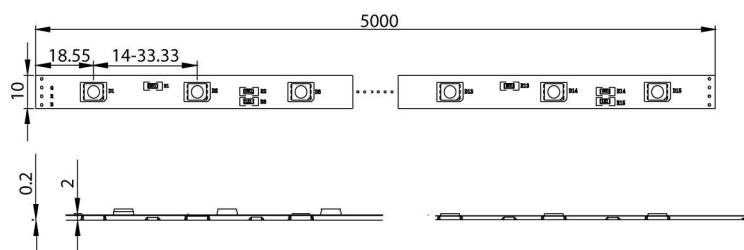

PHOTOMETRIC DATA

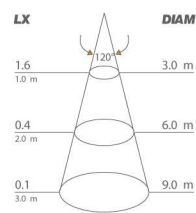
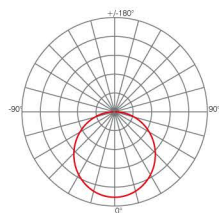

LC-LED STRIP-7.2W

LED STRIP LIGHT



SPECIFICATION

Light source : 5050 SMD LED
 LED Quantity : 30 pcs. LED/m.
 Power : 7.2W
 Input Voltage : 12Vdc
 Package : 5m. / Reel
 CRI : >90
 Beam Angle : 120°

Item No.	CCT	Unit Price
LC-GL-S5050W-30	5000K - 7000K	600.-
LC-GL-S5050WW-30	2500K - 3500K	600.-
LC-GL-S5050RGB-30	RGB	800.-

DIMENSION (Unit mm.)

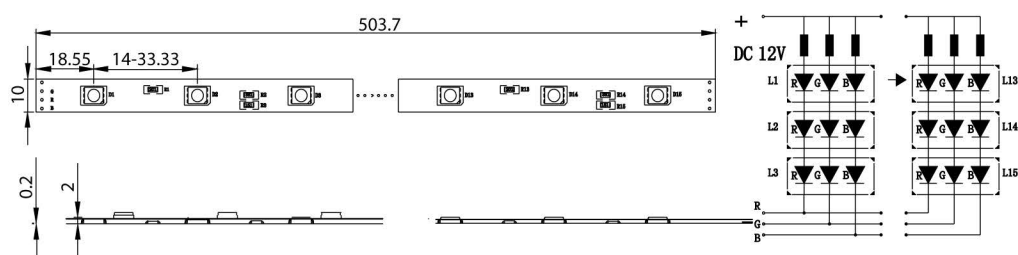

PHOTOMETRIC DATA

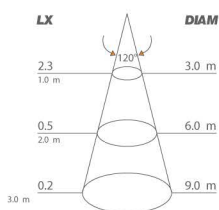
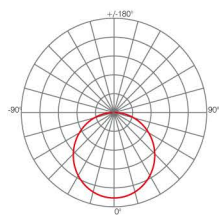

LC-LED STRIP-14.4W

LED STRIP LIGHT



SPECIFICATION

Light source	:	5050 SMD LED
LED Quantity	:	60 pcs. LED/m.
Power	:	14.4W
Input Voltage	:	12Vdc
Package	:	5m. / Reel
CRI	:	>90
Beam Angle	:	120°

Item No.	CCT	Unit Price
LC-GL-S5050W-60	6500K	800.-
LC-GL-S5050CW-60	4000K	800.-
LC-GL-S5050WW-60	3000K	800.-
LC-GL-S5050RGB-60	RGB	1,000.-

ACCESSORY

DIMENSION (Unit mm.)

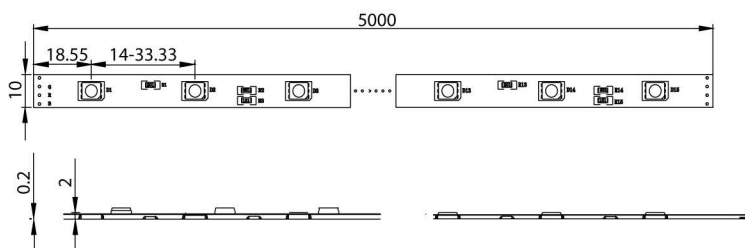

PHOTOMETRIC DATA

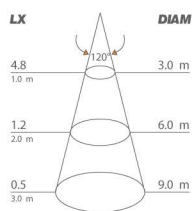
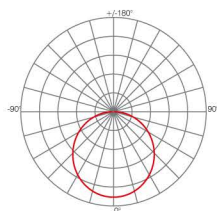

LC-LED Neon Flex 6x12mm.

LED Neon Flex



SPECIFICATION

Watt	: 6W/m.
Light source	: LED
Lumen	: 179 lm/m.
Lumen/Watt	: 29.8 lm/W
CCT	: 3000K
CRI	: >80
Beam Angle	: 120°
Material	: Silicone
IP	: 67
Driver Type	: Remote Driver
Input Voltage	: 24Vdc
Dimension (WxLxH) mm:	6 x 5000 x 12 mm.
Cutting (mm.)	: 50 mm.

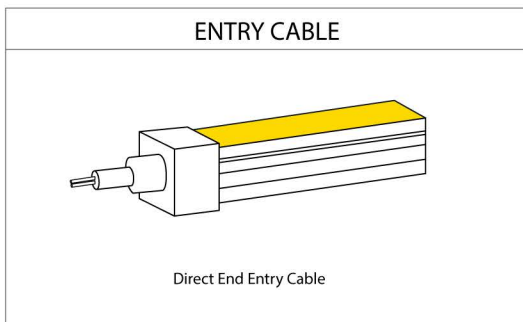
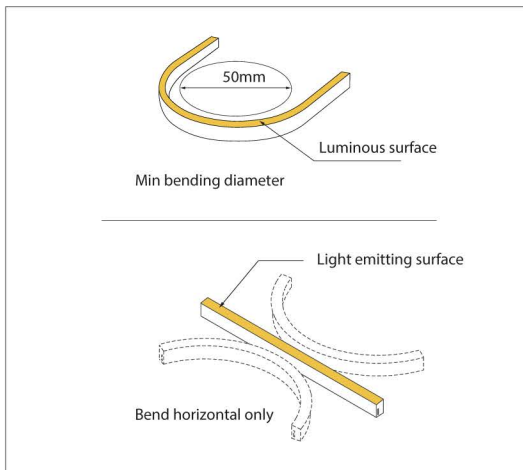

PHOTOMETRIC DATA

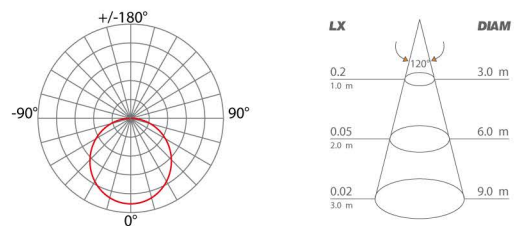

DIMENSION (Unit mm.)

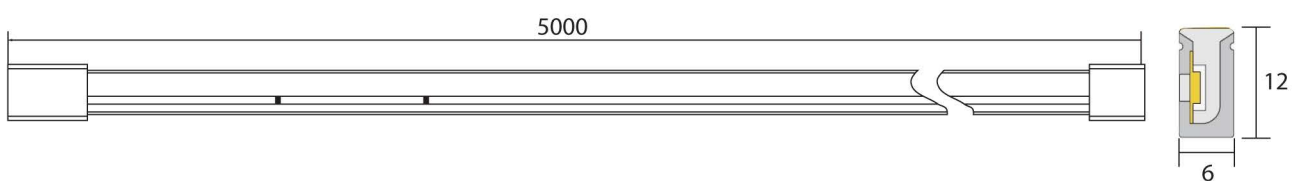

ALUMINIUM PROFILE

LC-U1-1M

ALUMINIUM PROFILE



DIMENSION mm.

(W x D x H) : 14x1000x8 mm

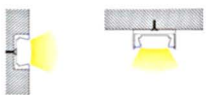
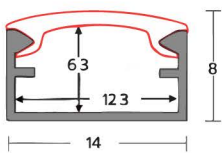

LC-U-CHANNEL 1M

ALUMINIUM PROFILE



DIMENSION mm.

(W x D x H) : 17x1000x8 mm

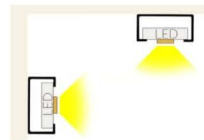
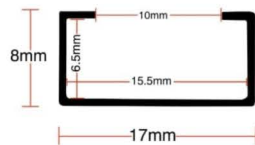

LC-YC-002 1M/2.5M

ALUMINIUM PROFILE



DIMENSION mm.

(W x D x H) : 17x1000x7 mm
17x2500x7 mm

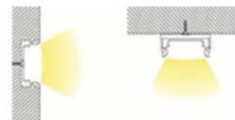
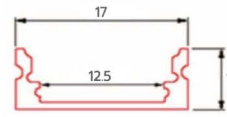

LC-YC-001 1M/2.5M

ALUMINIUM PROFILE



DIMENSION mm.

(W x D x H) : 17x1000x7 mm
17x2500x7 mm

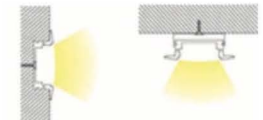
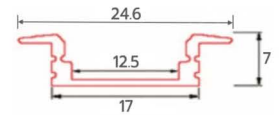

LC-YC-035 1M/2.5M

ALUMINIUM PROFILE



DIMENSION mm.

(W x D x H) : 10x1000x12.8 mm
10x2500x12.8 mm

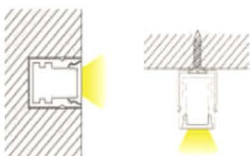
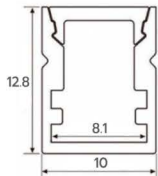

LC-YC-067 1M/2.5M

ALUMINIUM PROFILE



DIMENSION mm.

(W x D x H) : 15.7x1000x6.8 mm
15.7x2500x6.8 mm

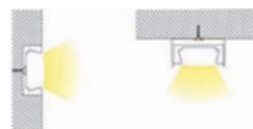
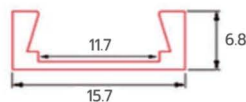

LC-YC-068 1M

ALUMINIUM PROFILE



DIMENSION mm.

(W x D x H) : 15.7x1000x6.8 mm

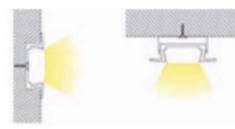
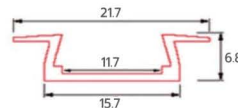

LC-YC-611 1M

ALUMINIUM PROFILE



DIMENSION mm.

(W x D x H) : 15.8x1000x11.9 mm

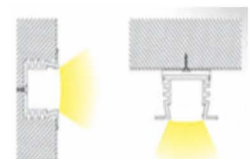
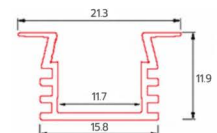

ALUMINIUM PROFILE

LC-YC-612 1M/2.5M
ALUMINIUM PROFILE

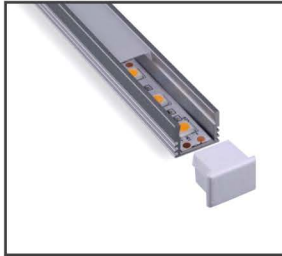

DIMENSION mm.

(W x D x H) : 15.8x1000x12.1 mm
15.8x2500x12.1 mm

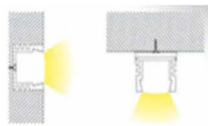
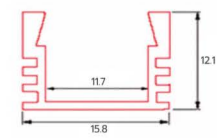

LC- YC-036 1M/2.5M
ALUMINIUM PROFILE



DIMENSION mm.

(W x D x H) : 7.8x1000x9 mm
7.8x2500x9 mm

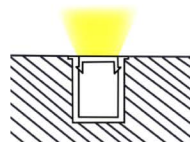
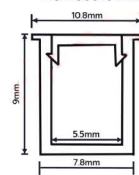

LC-YC-003 1M/2.5M
ALUMINIUM PROFILE



DIMENSION mm.

(W x D x H) : 17.3x1000x14.3 mm
17.3x2500x14.3 mm

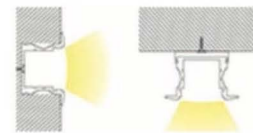
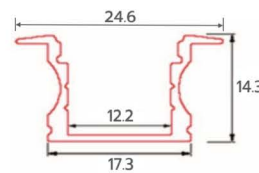

LC-YC-004 1M/2.5M
ALUMINIUM PROFILE



DIMENSION mm.

(W x D x H) : 17.3x1000x14.3 mm
17.3x2500x14.3 mm

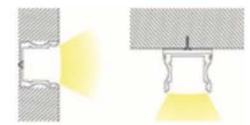
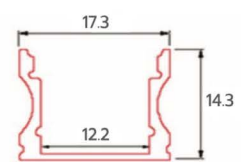

LC-YC-006 1M/2.5M
ALUMINIUM PROFILE



DIMENSION mm.

(W x D x H) : 16x1000x16 mm
16x2500x16 mm

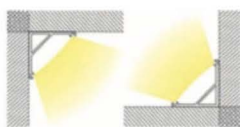
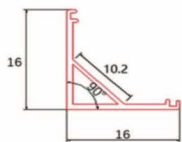

LC-YC-005 1M/2.5M
ALUMINIUM PROFILE



DIMENSION mm.

(W x D x H) : 16x1000x16 mm
16x2500x16 mm

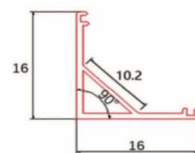

LC-U2 1M
ALUMINIUM PROFILE



DIMENSION mm.

(W x D x H) : 18x1000x14 mm

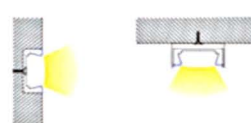
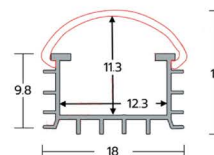

LC-YC-014 1M/2.5M
ALUMINIUM PROFILE



DIMENSION mm.

(W x D x H) : 23.5x1000x9.7 mm
23.5x2500x9.7 mm

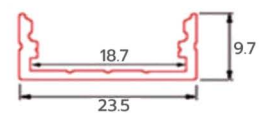

ALUMINIUM PROFILE

LC-YC-007 1M/2.5M

ALUMINIUM PROFILE



DIMENSION mm.

(W x D x H) : 17.8x1000x17.8 mm
17.8x2500x17.8 mm

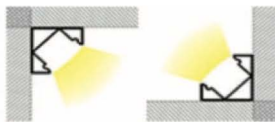
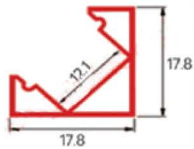

LC-YC-010 1M

ALUMINIUM PROFILE

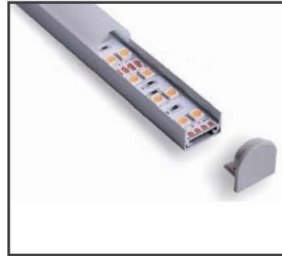

DIMENSION mm.

(W x D x H) : 19.3x1000x11.1 mm

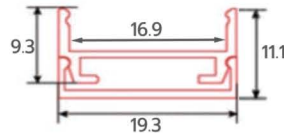

LC-YC-011 1M/2.5M

ALUMINIUM PROFILE

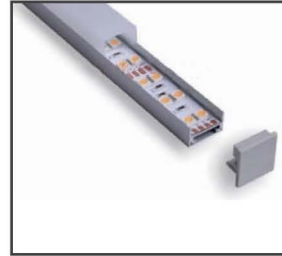

DIMENSION mm.

(W x D x H) : 19.3x1000x11.1 mm
19.3x2500x11.1 mm

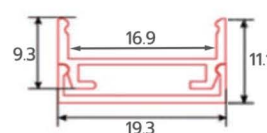

LC-YC-043 1M

ALUMINIUM PROFILE



DIMENSION mm.

(W x D x H) : 16.9x1000x14.7 mm

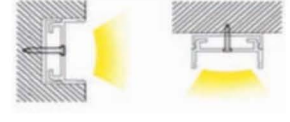
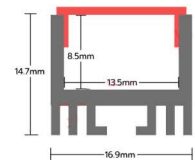

LC-YC-013 1M/2.5M

ALUMINIUM PROFILE



DIMENSION mm.

(W x D x H) : 23.5x1000x9.7 mm
23.5x2500x9.75 mm

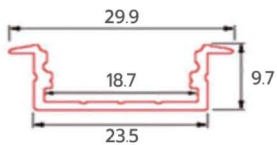

LC-YC-016 1M

ALUMINIUM PROFILE



DIMENSION mm.

(W x D x H) : 30x1000x30 mm

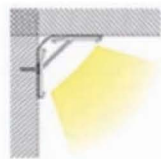
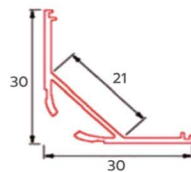

LC-YC-015 1M/2.5M

ALUMINIUM PROFILE



DIMENSION mm.

(W x D x H) : 30x1000x30 mm
30x2500x30 mm

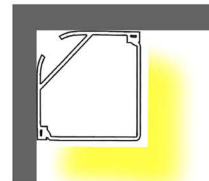
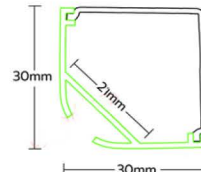

LC-YC-008 1M

ALUMINIUM PROFILE



DIMENSION mm.

(W x D x H) : 20.5x1000x14 mm

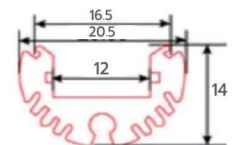

ALUMINIUM PROFILE

LC-YC-034 1M

ALUMINIUM PROFILE

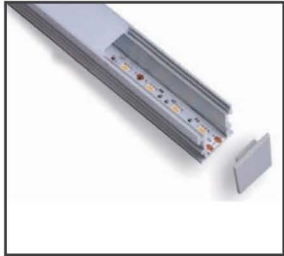

DIMENSION mm.

(W x D x H) : 21.3x1000x25.8 mm

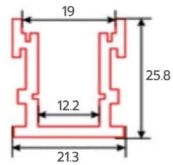

LC-YC-018 1M/2.5M

ALUMINIUM PROFILE



DIMENSION mm.

(W x D x H) : 35x1000x35 mm
35x2500x35 mm

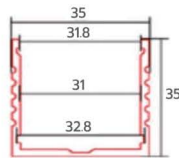

LC-YC-017 1M

ALUMINIUM PROFILE



DIMENSION mm.

(W x D x H) : 44.1x1000x35 mm

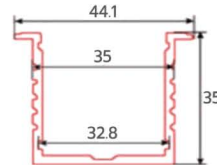

LC-YC-033 1M

ALUMINIUM PROFILE



DIMENSION mm.

(W x D x H) : 21.4x1000x10.9 mm

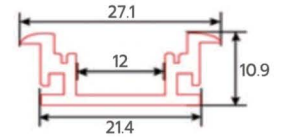

LC-YC-3030 1M/2.5M

ALUMINIUM PROFILE



DIMENSION mm.

(W x D x H) : 30x1000x30 mm
30x2500x30 mm

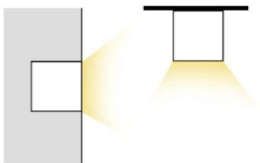
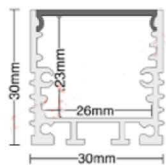

LC-YC-031 1M

ALUMINIUM PROFILE



DIMENSION mm.

(W x D x H) : 35.8x1000x27.3 mm

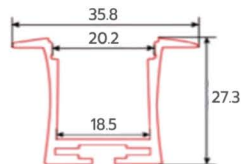

LC-YC-028 1M/2.5M

ALUMINIUM PROFILE



DIMENSION mm.

(W x D x H) : 20x1000x10.7 mm
20x2500x10.7 mm

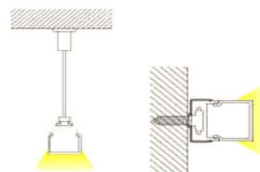
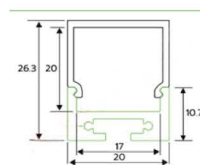

LC-YC-046 1M/2.5M

ALUMINIUM PROFILE



DIMENSION mm.

(W x D x H) : 50x1000x35 mm
50x2500x35 mm

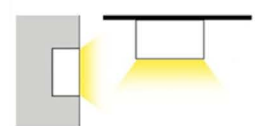
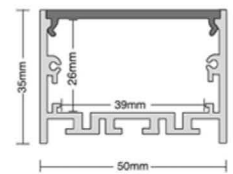

ALUMINIUM PROFILE

LC-YC-045 1M/2.5M
ALUMINIUM PROFILE

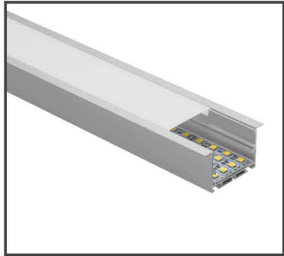

DIMENSION mm.

(W x D x H) : 50x1000x35 mm
50x2500x35 mm

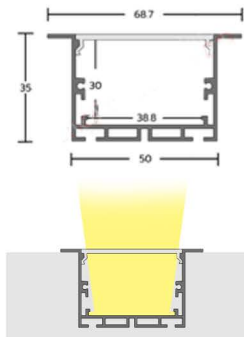

LC-YC-108 1M/2.5M
ALUMINIUM PROFILE



DIMENSION mm.

(W x D x H) : 54.8x1000x32.8 mm
54.8x2500x32.8 mm

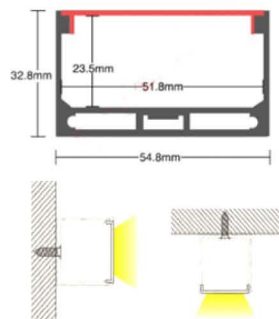

LC-YC-0128 1M/2.5M
ALUMINIUM PROFILE



DIMENSION mm.

(W x D x H) : 75x1000x35 mm
75x2500x35 mm

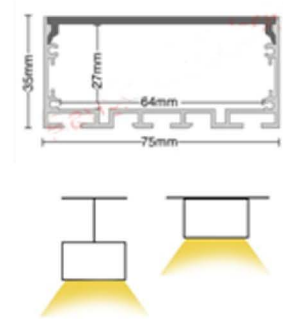

LC-YC-159 3M
ALUMINIUM PROFILE



DIMENSION mm.

(W x D x H) : 50x3000x50 mm

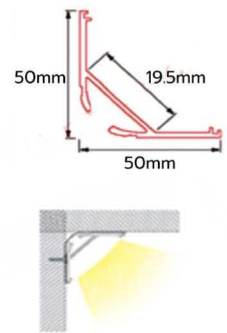

LC-YC-159 3M
ALUMINIUM PROFILE



DIMENSION mm.

(W x D x H) : 50x3000x50 mm

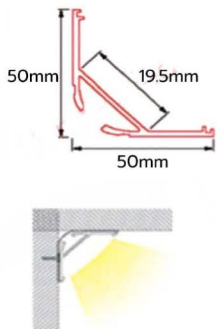

LC-YC-01035 1M/2.5M
ALUMINIUM PROFILE



DIMENSION mm.

(W x D x H) : 102.1x1000x35 mm
102.1x2500x35 mm

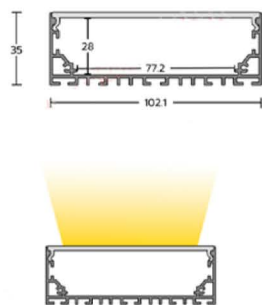

LC-YC-01035P 1M/2.5M
ALUMINIUM PROFILE



DIMENSION mm.

(W x D x H) : 102.1x1000x35 mm
102.1x2500x35 mm

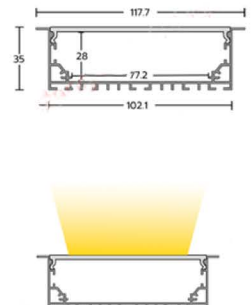

LC-YC-12035 2.5M
ALUMINIUM PROFILE



DIMENSION mm.

(W x D x H) : 102.6x2500x35 mm

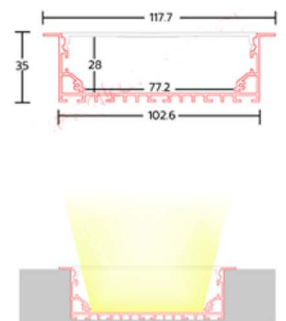

www.southeastthailand.co.th